

1

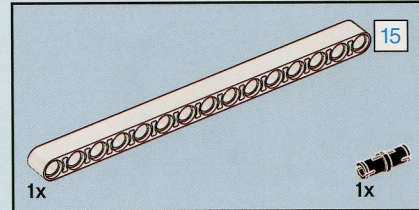

2

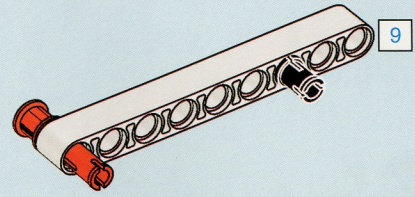
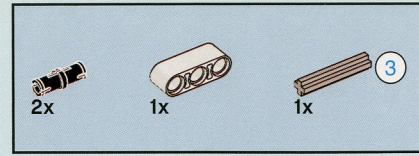
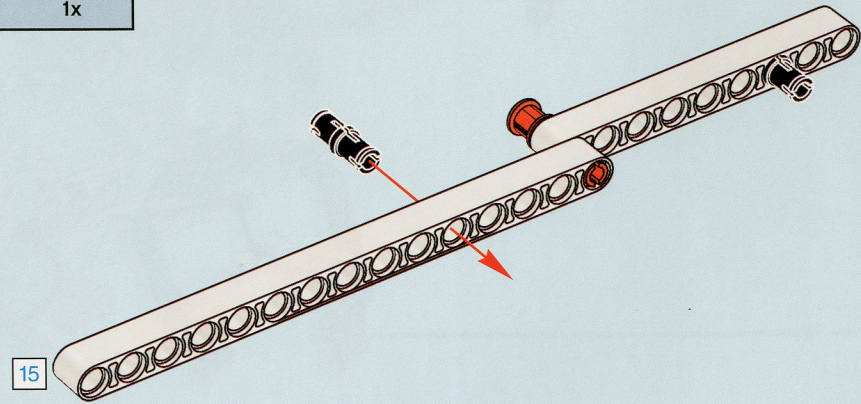

3

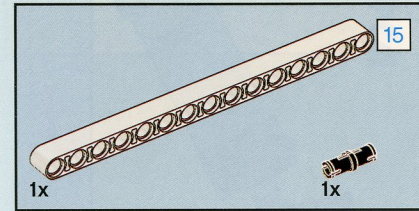
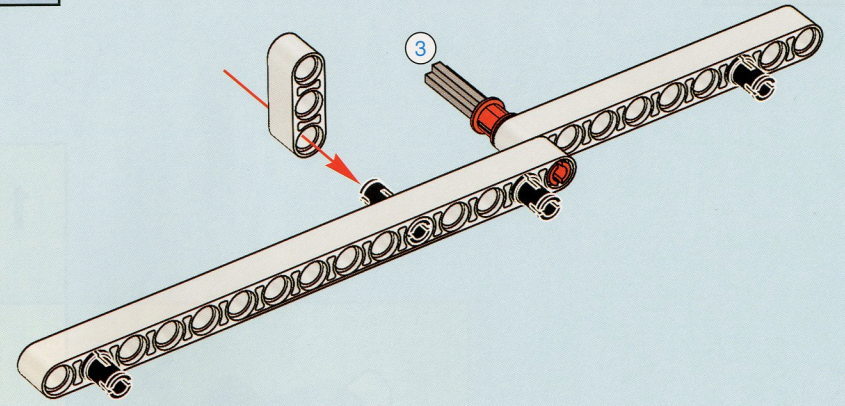

4

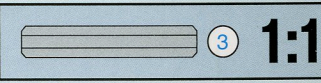
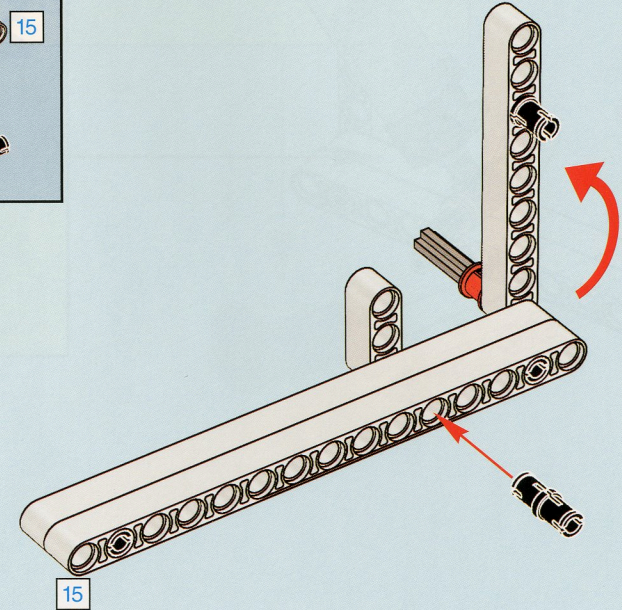

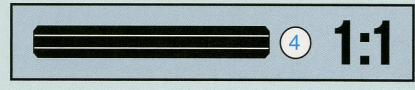
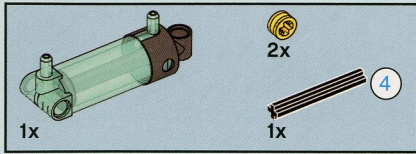

5

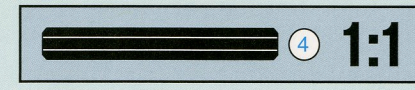
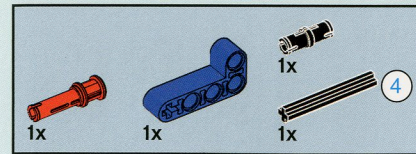
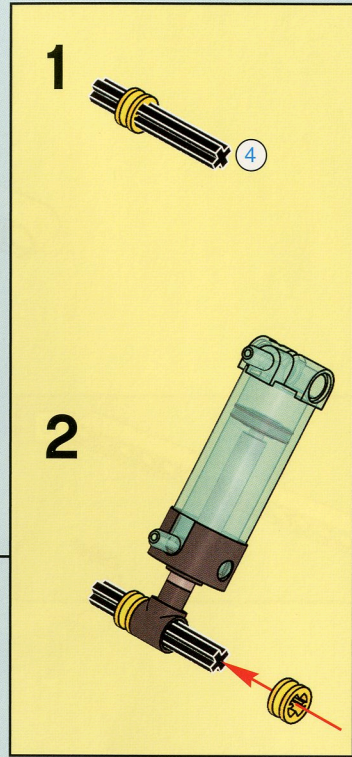
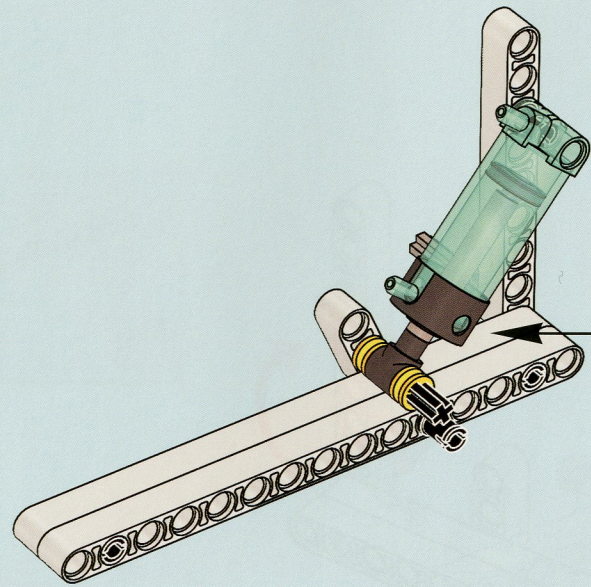

6

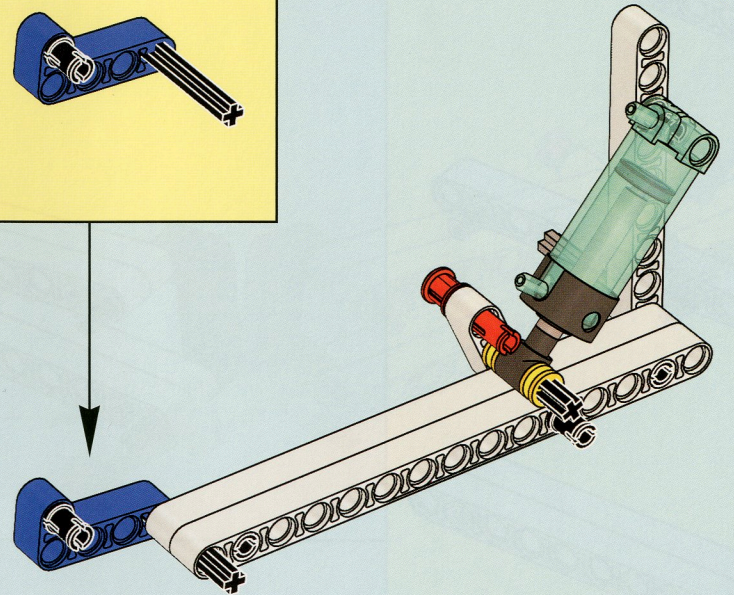
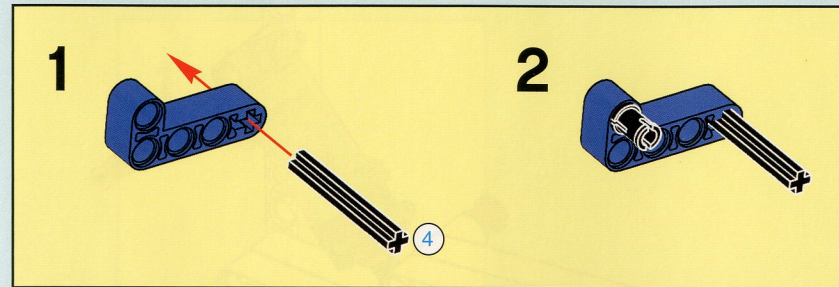

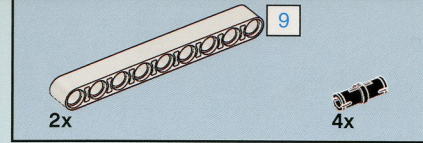

7

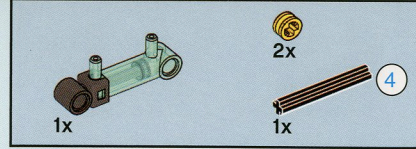
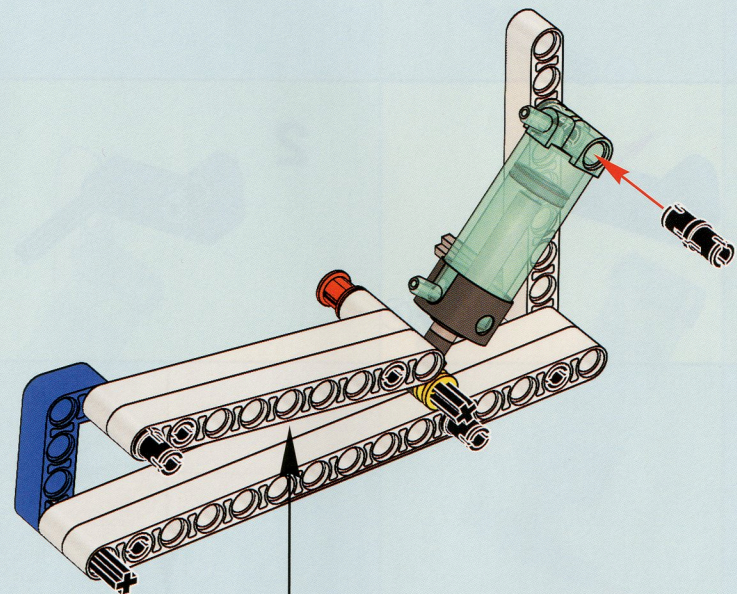
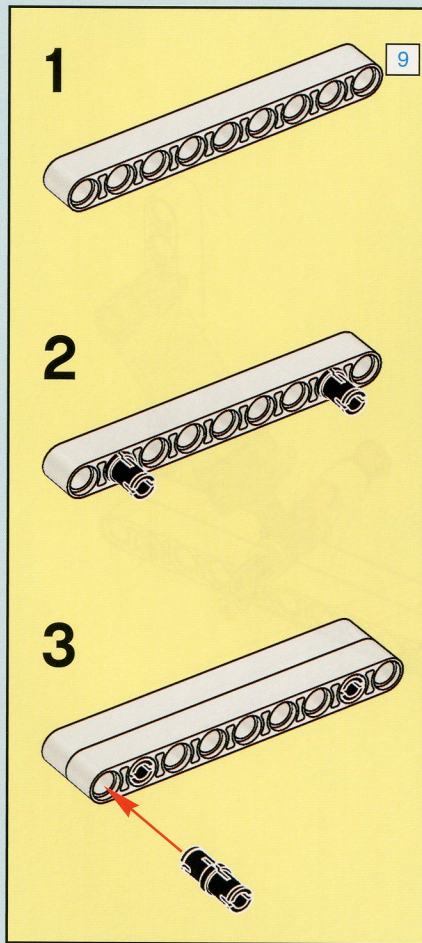

8

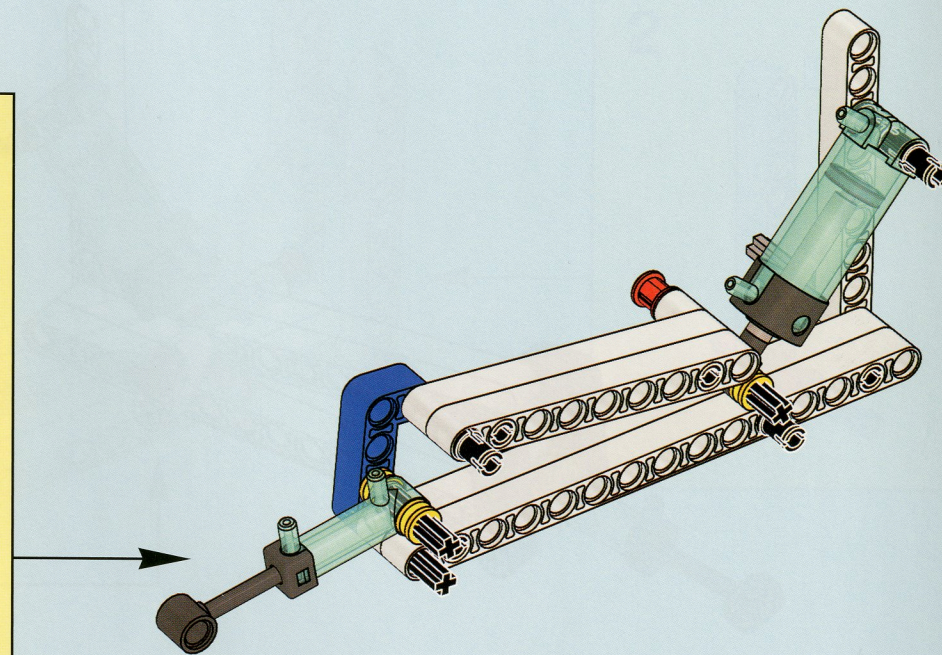
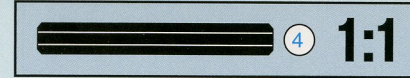
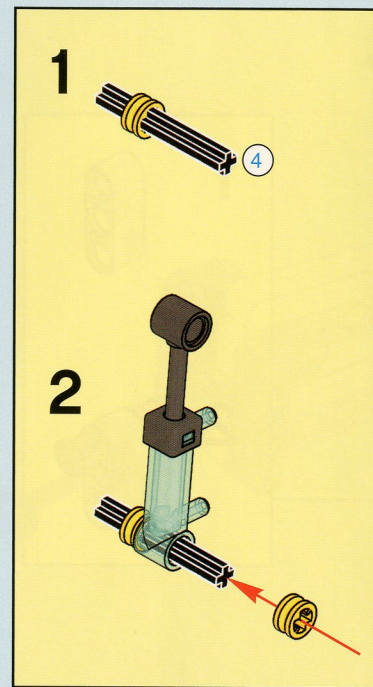

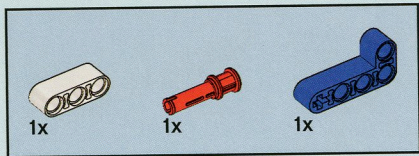

9

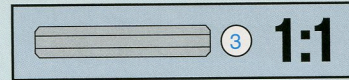
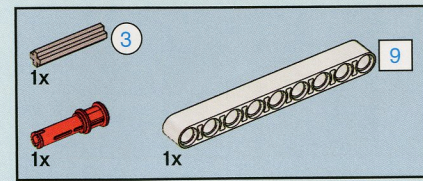
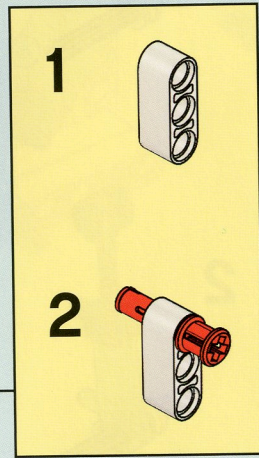
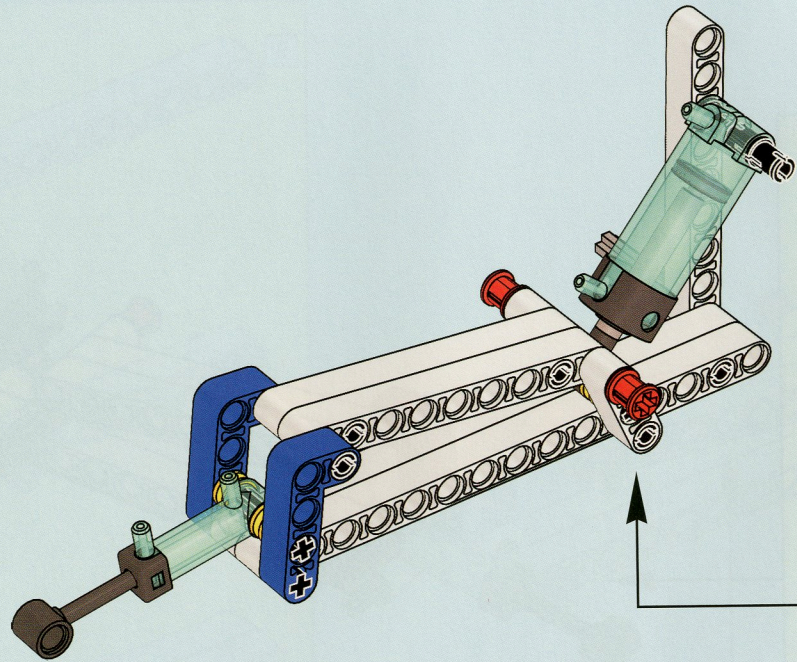

10

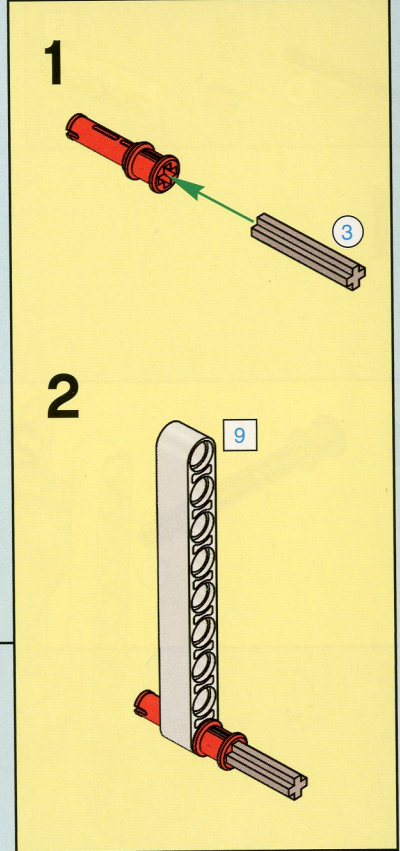
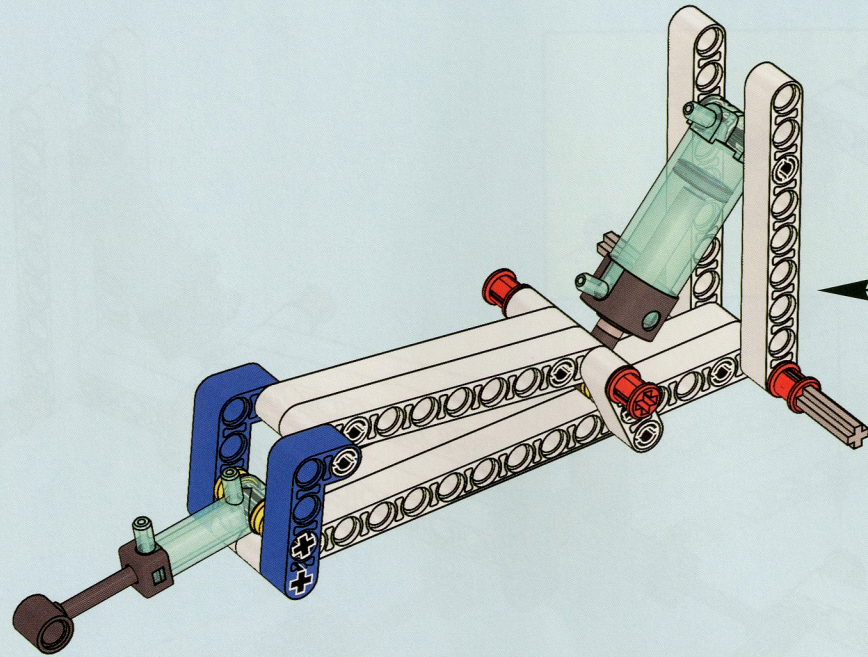

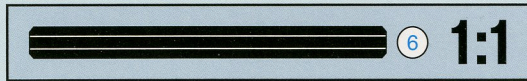
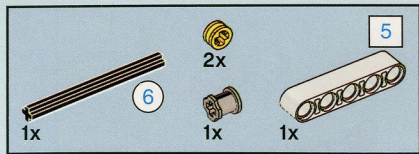

# 11

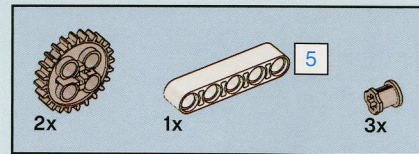
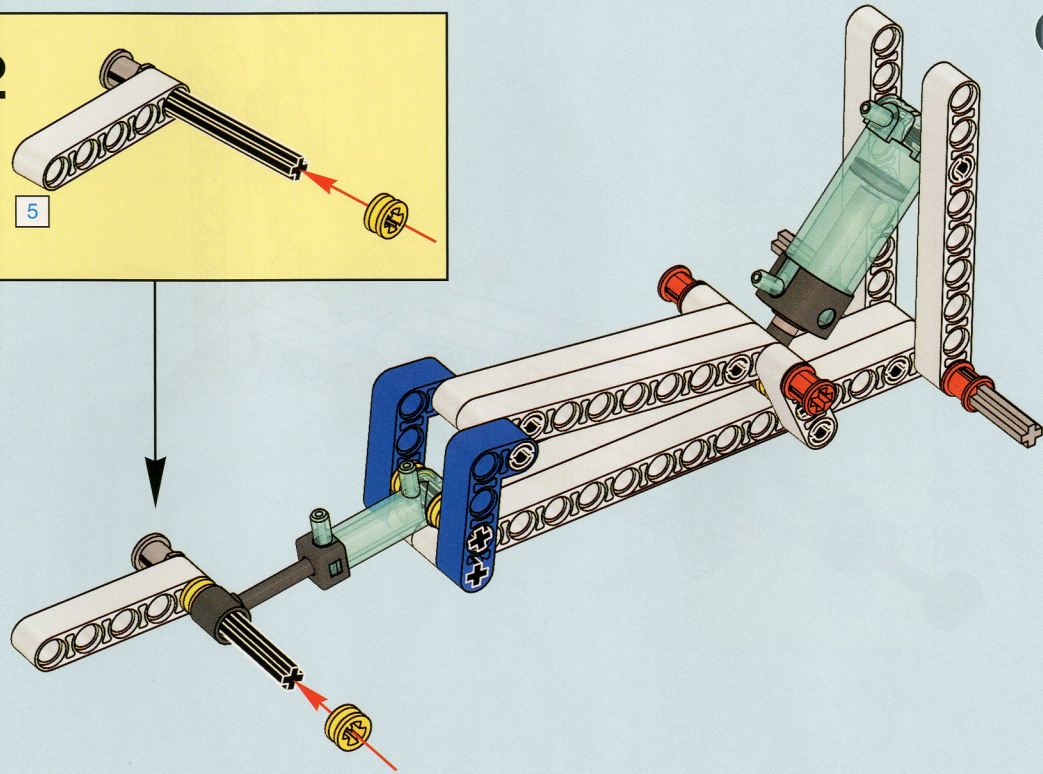
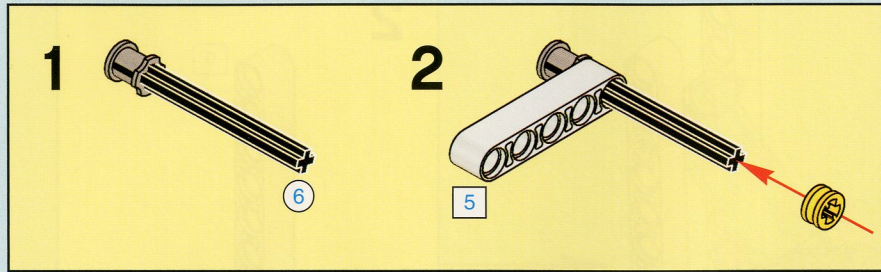

# 12

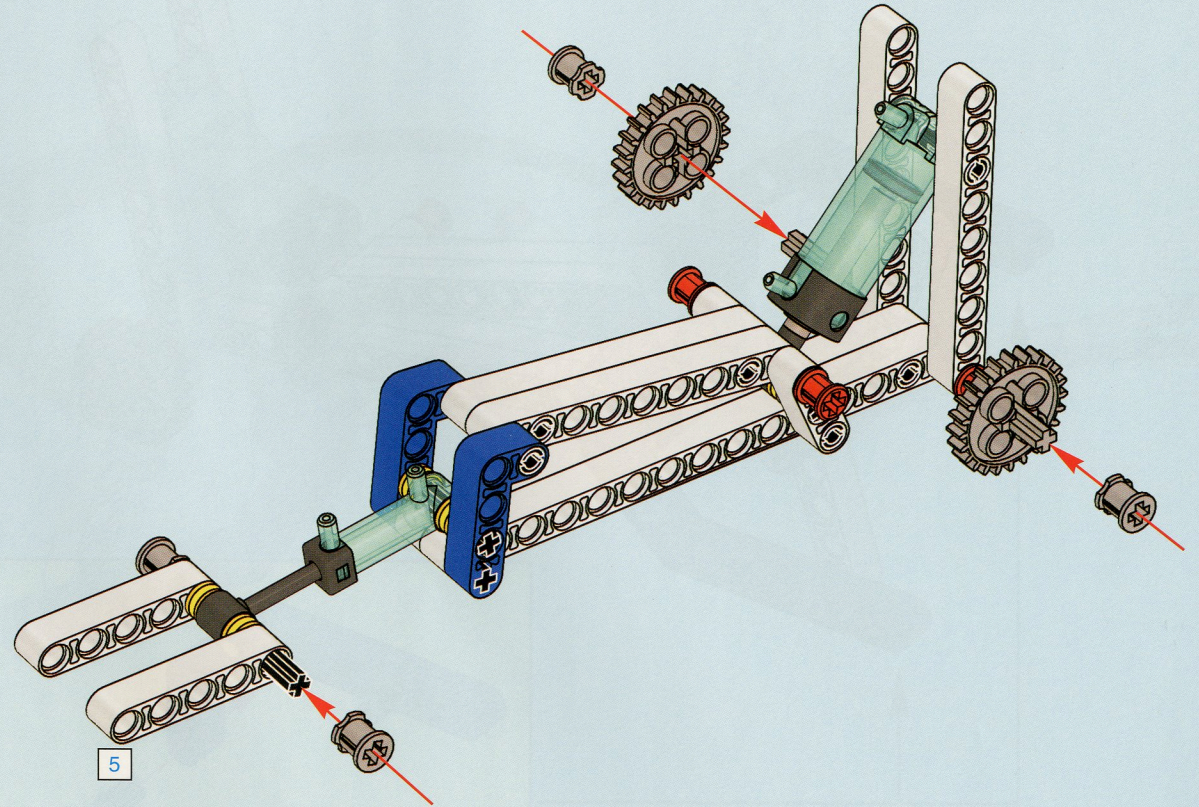

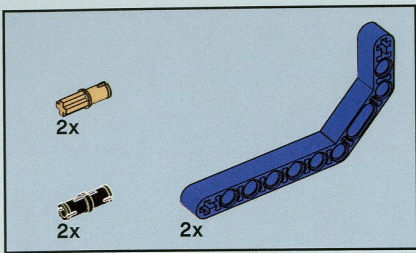

13

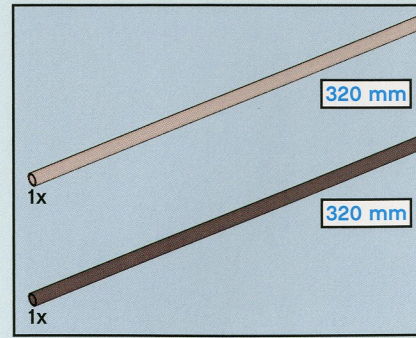
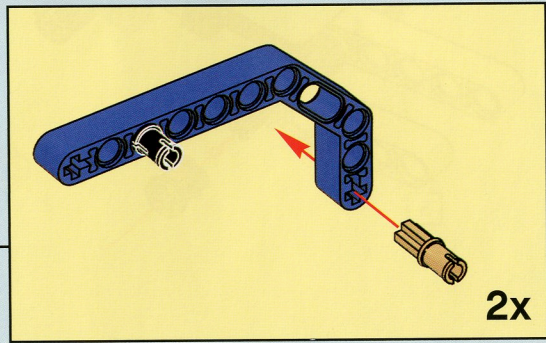
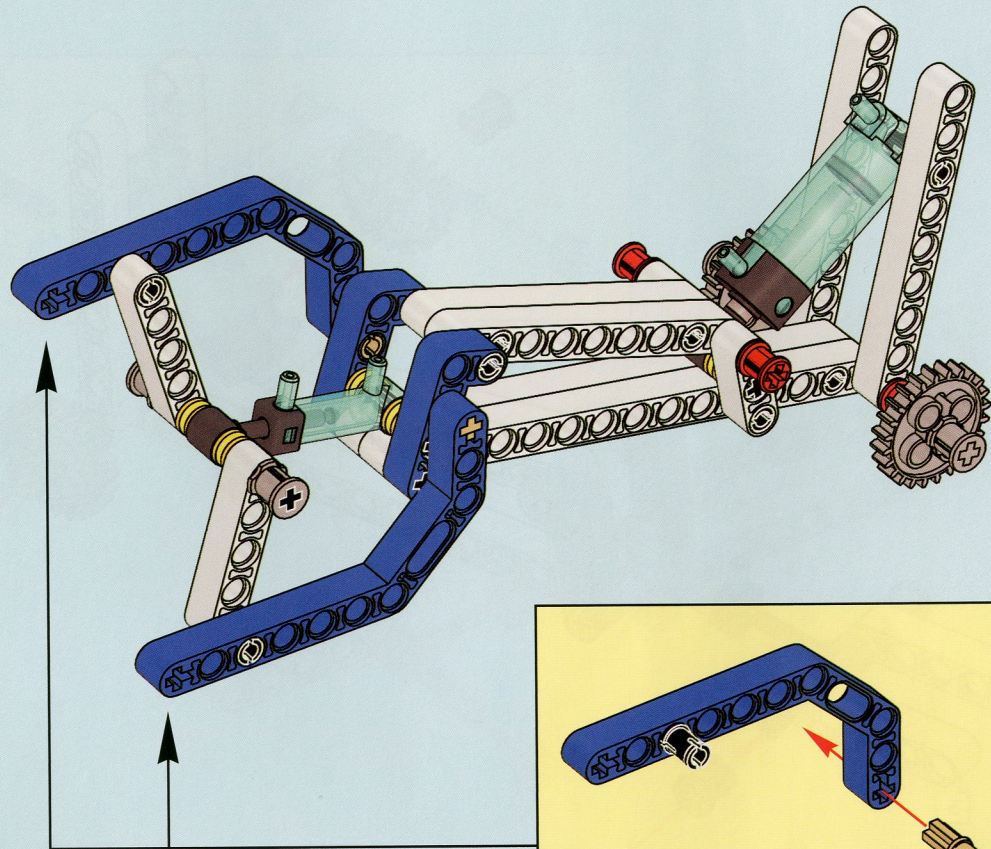

14

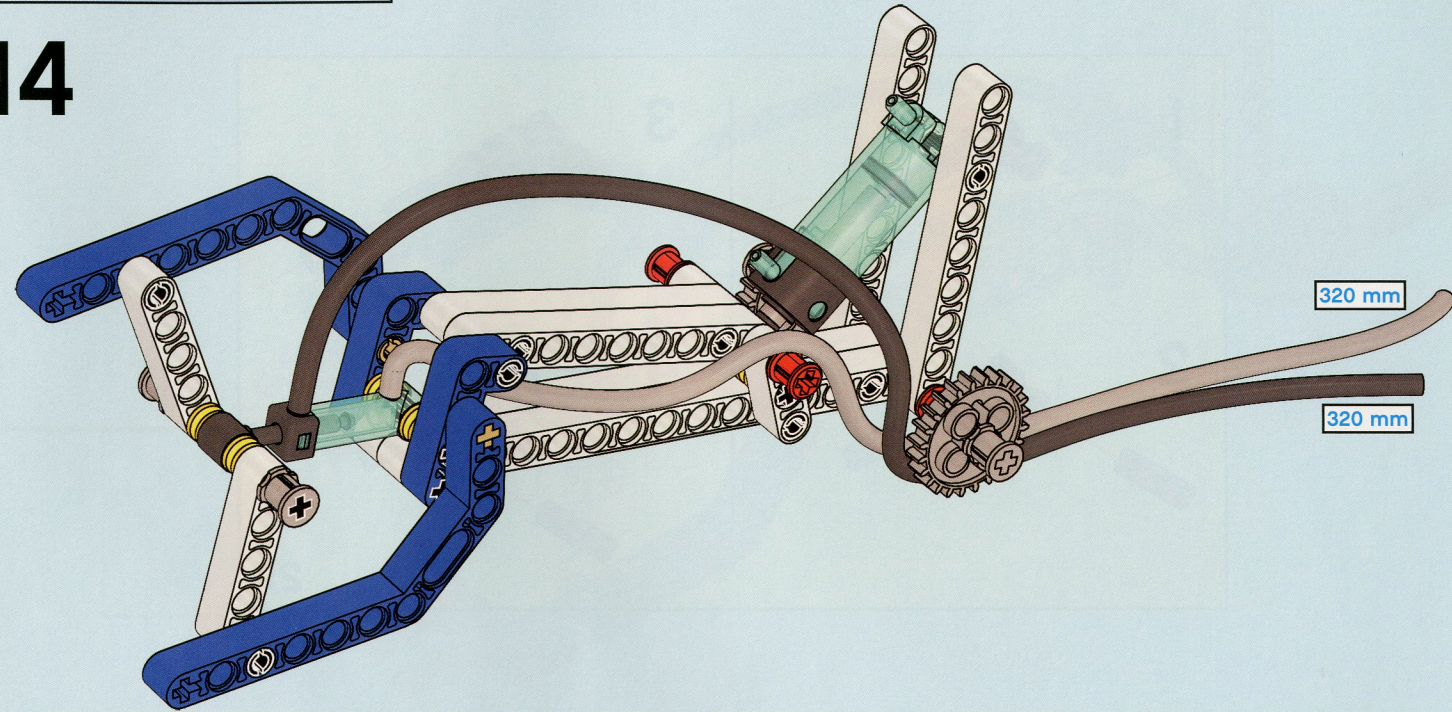

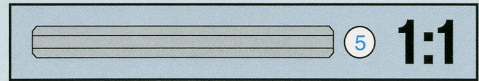
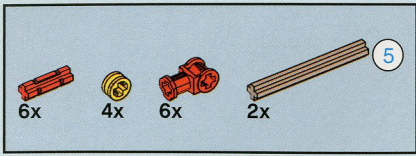

# 15

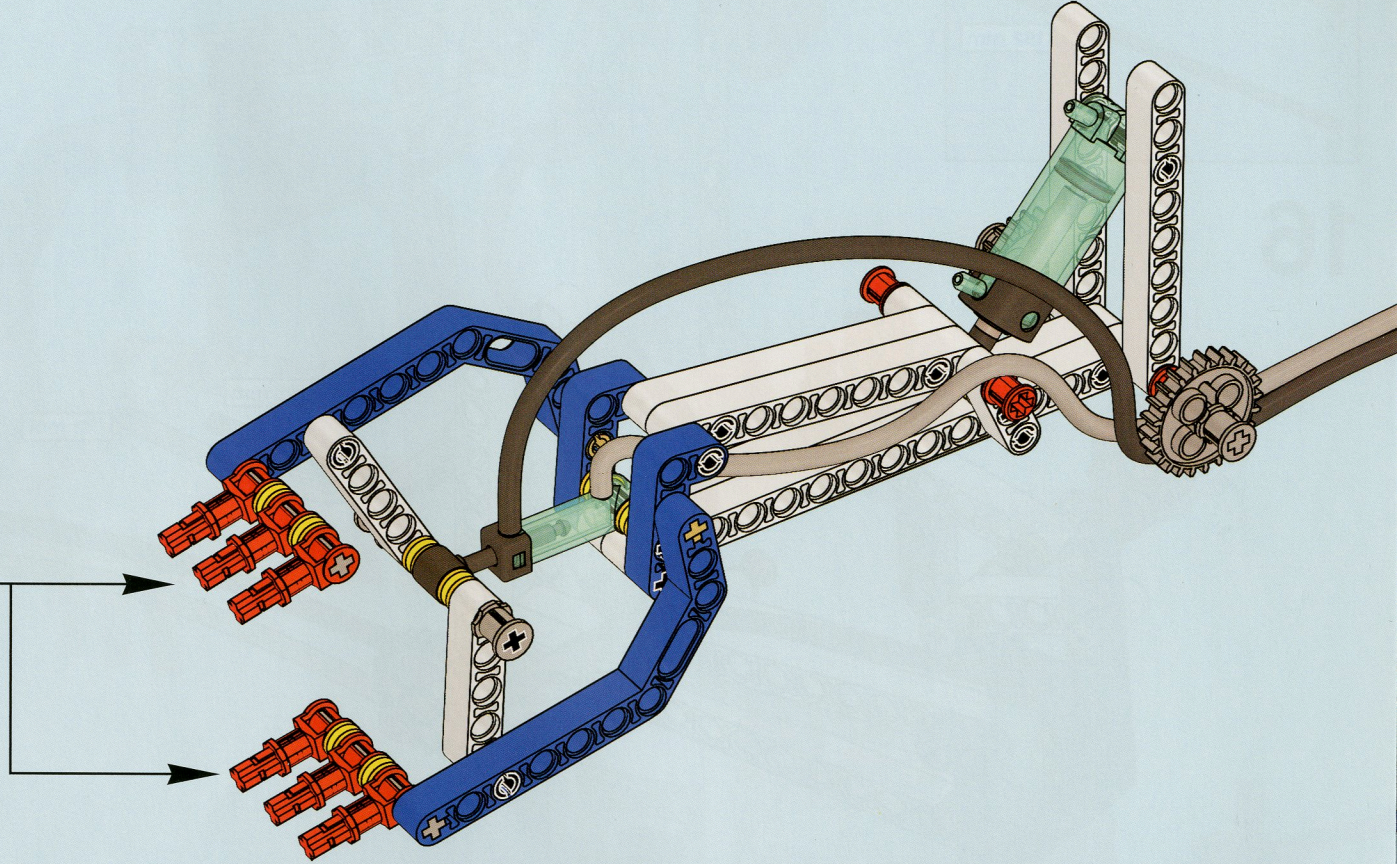
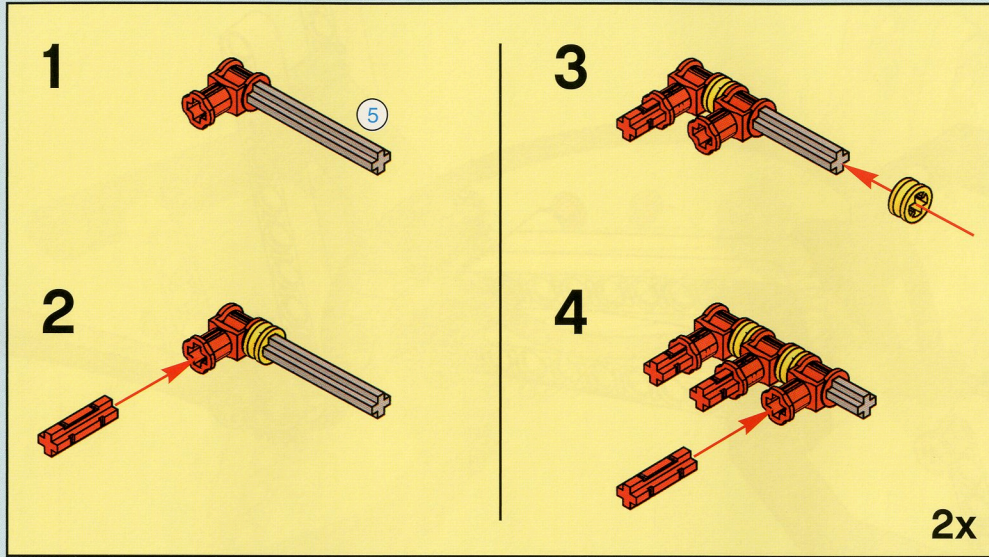

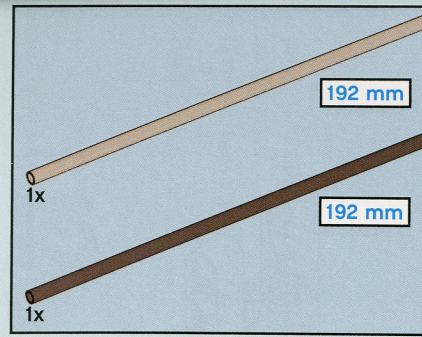

16

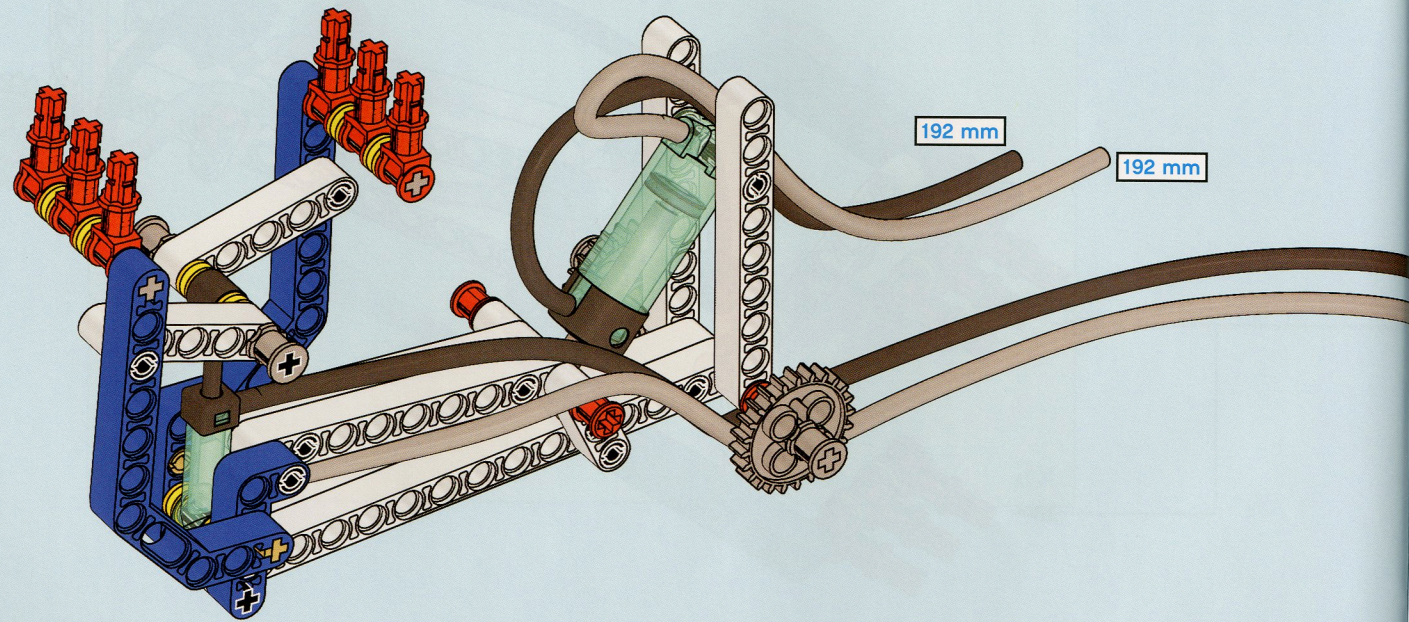

17

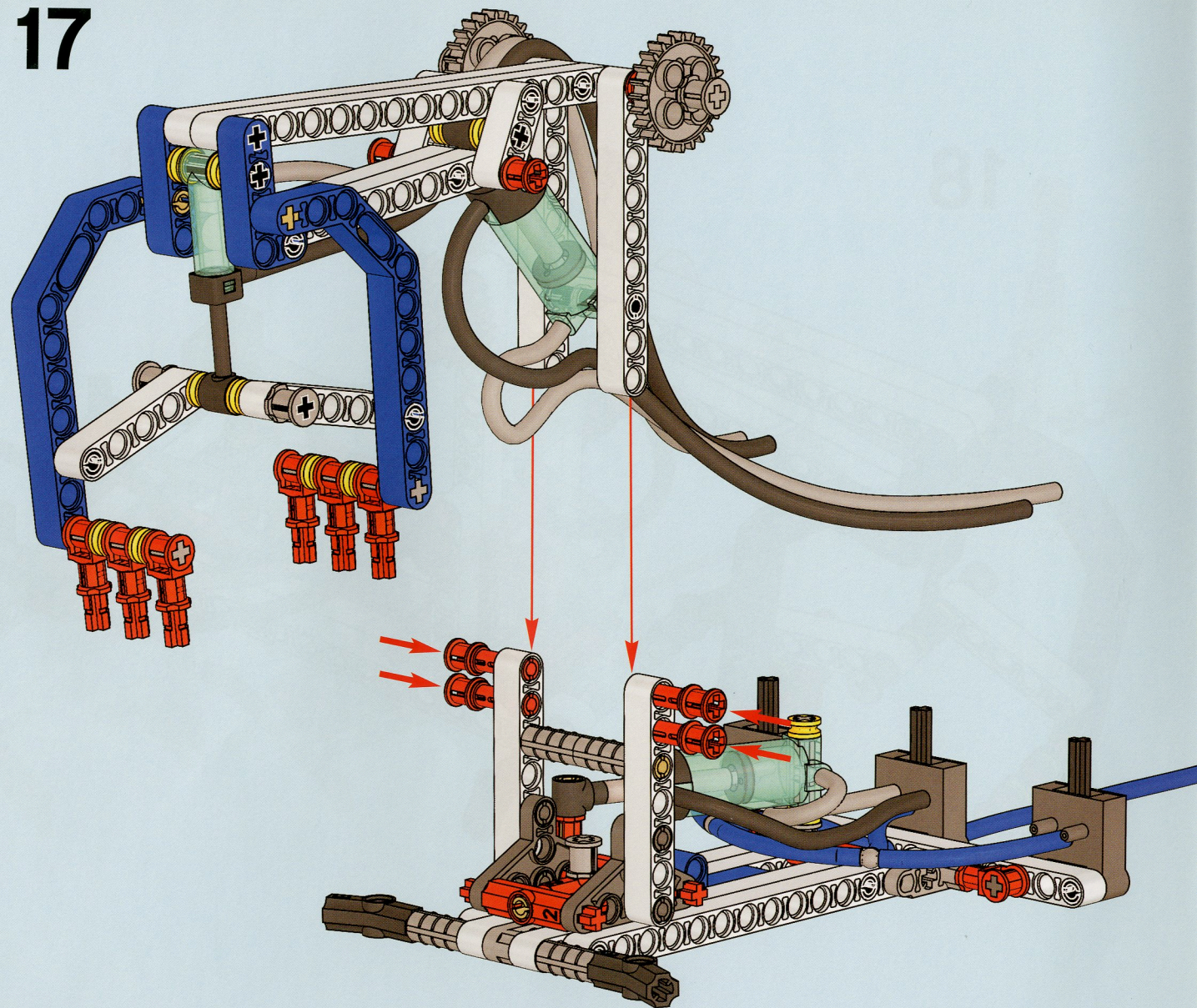



18

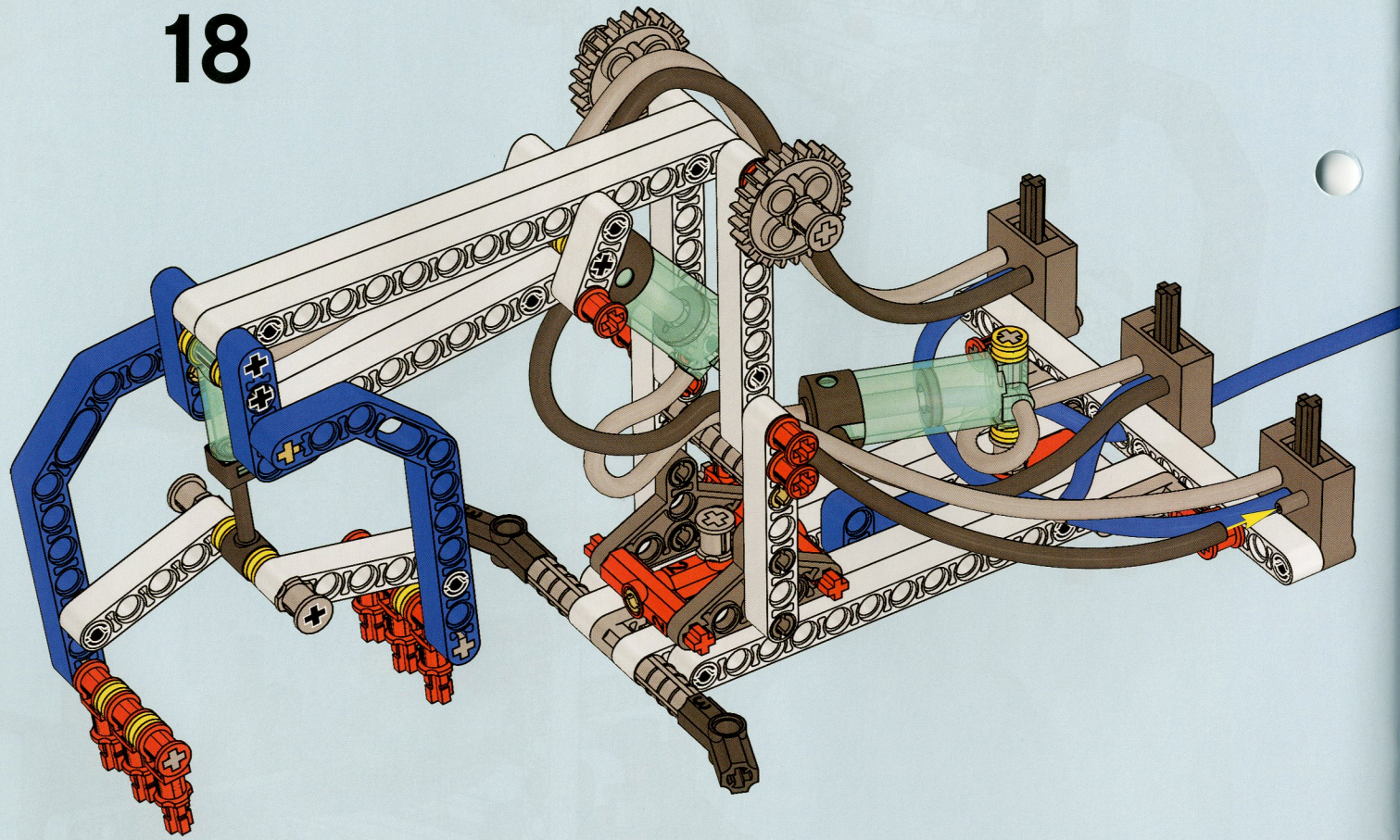

19

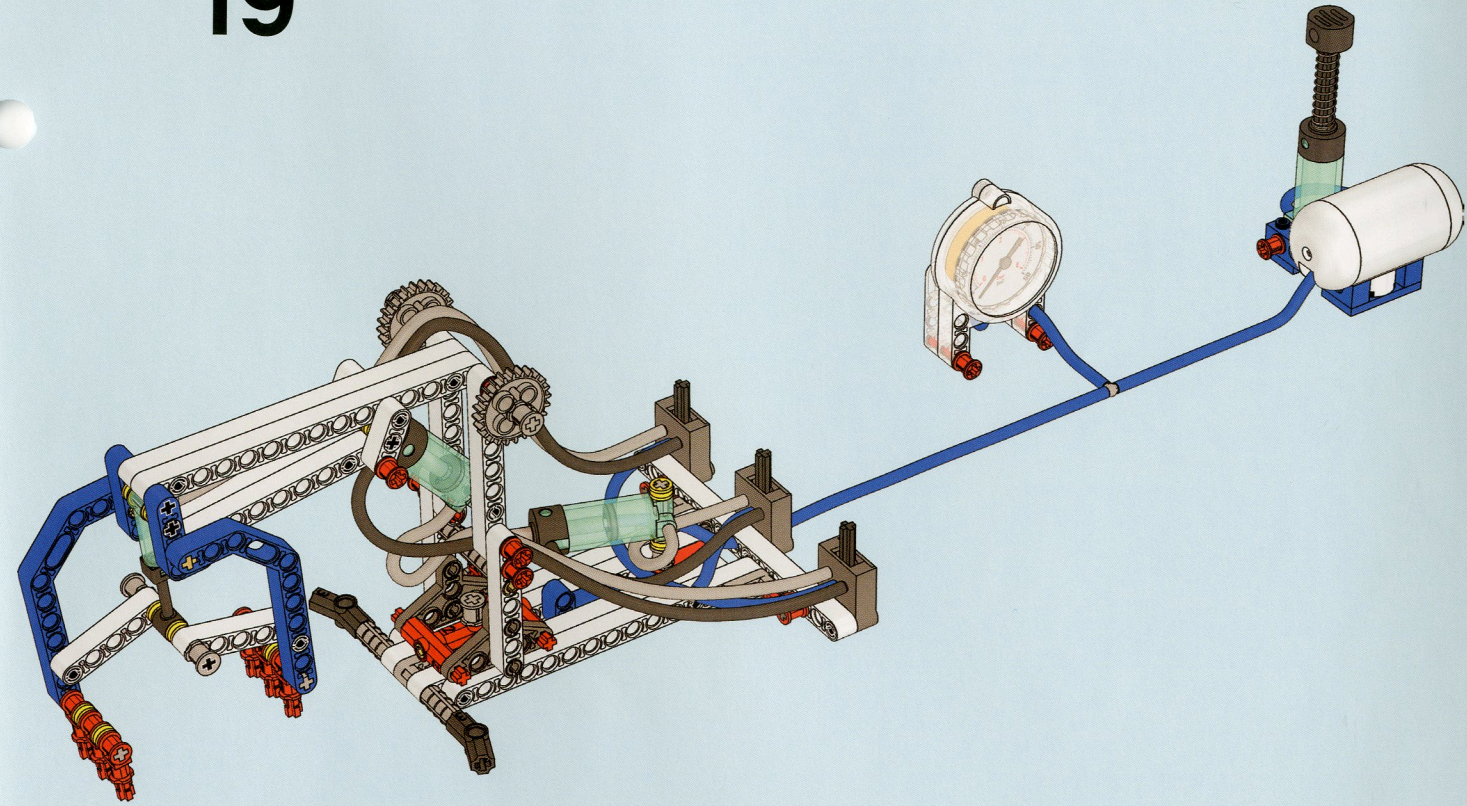

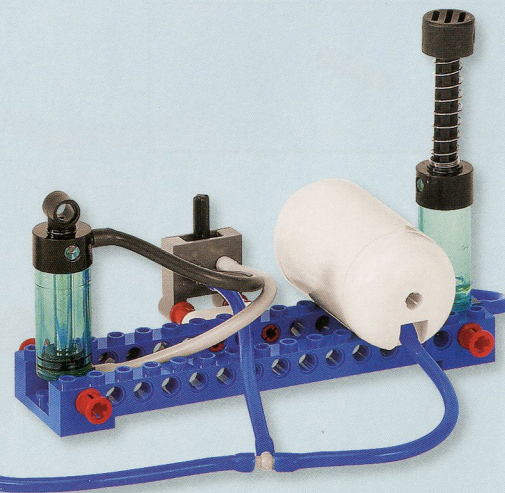
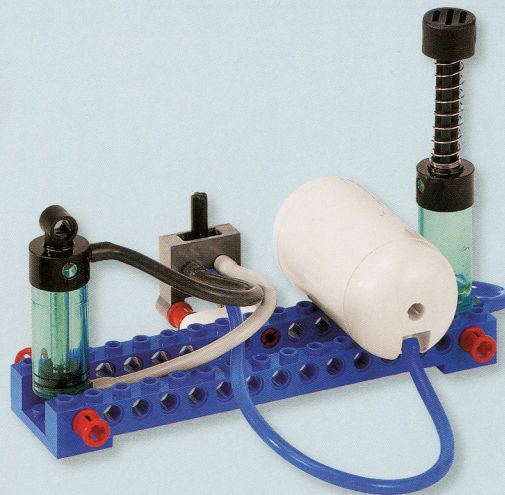
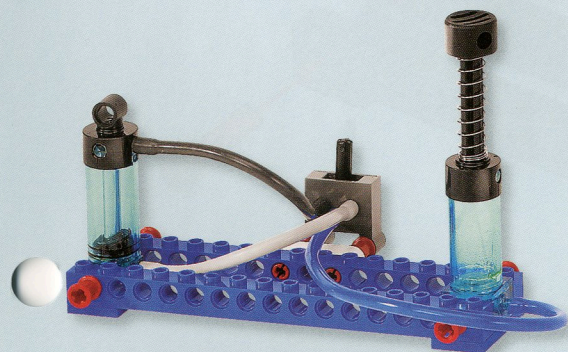
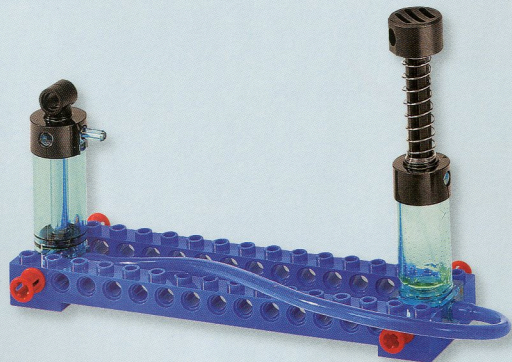
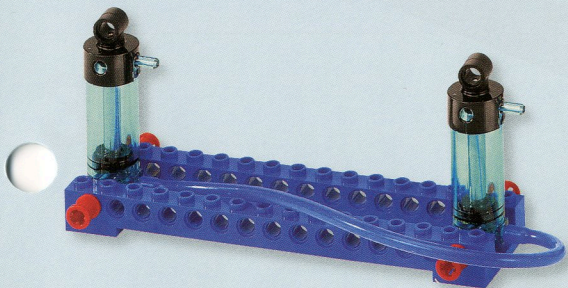

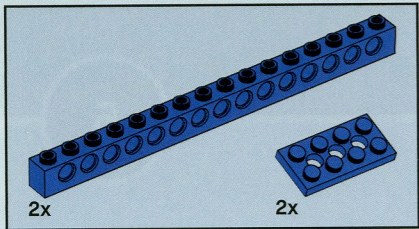

1

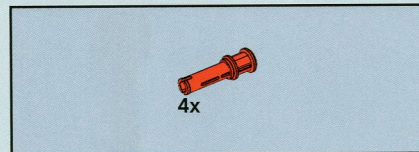
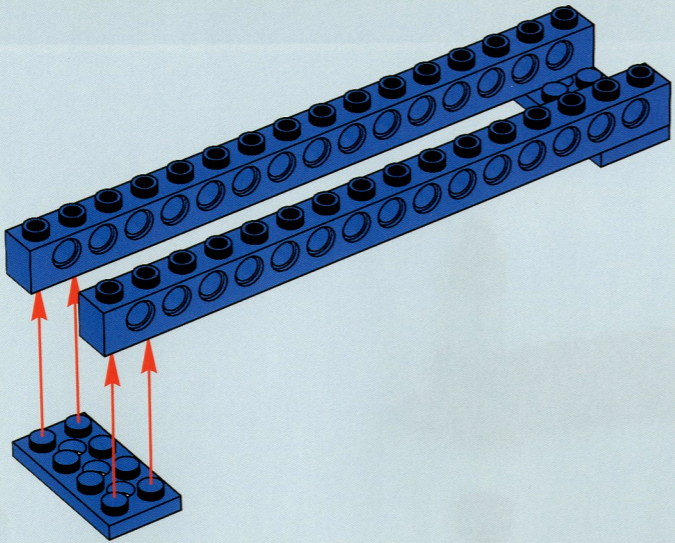

2

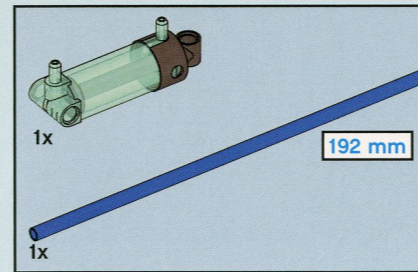
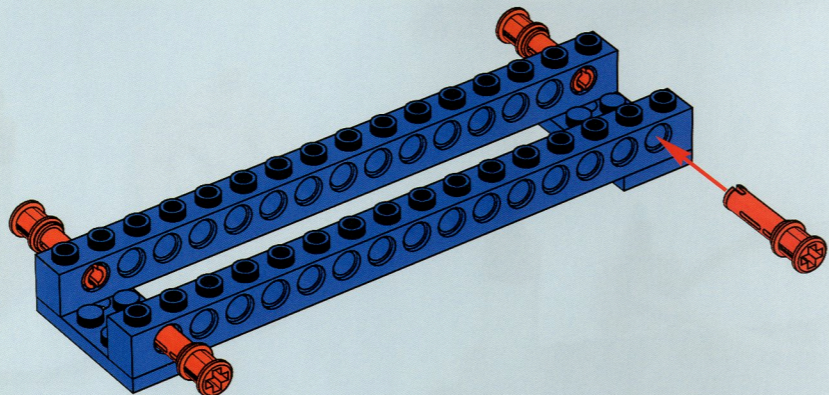

3

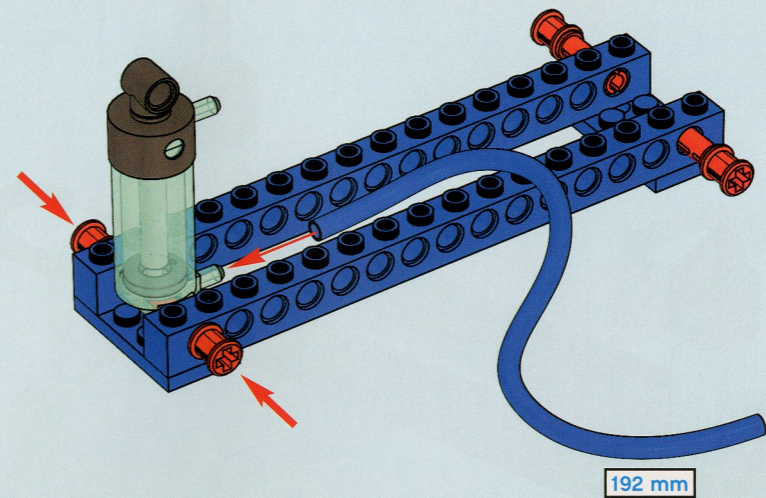

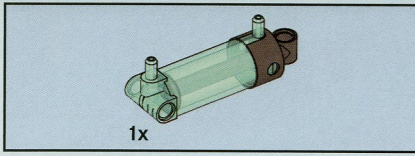

4

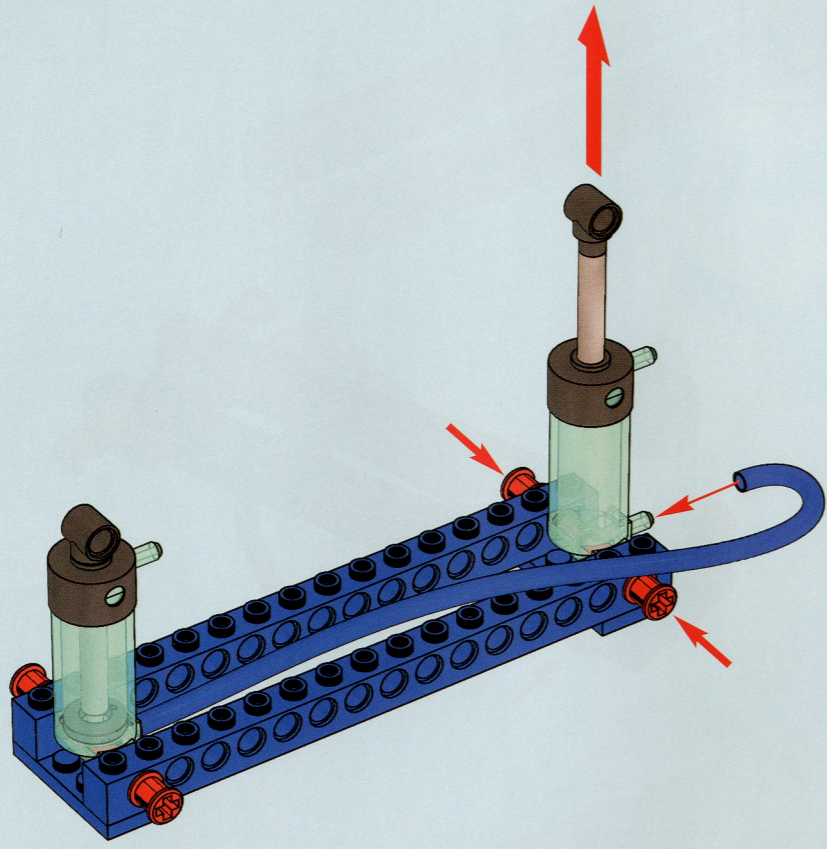

5

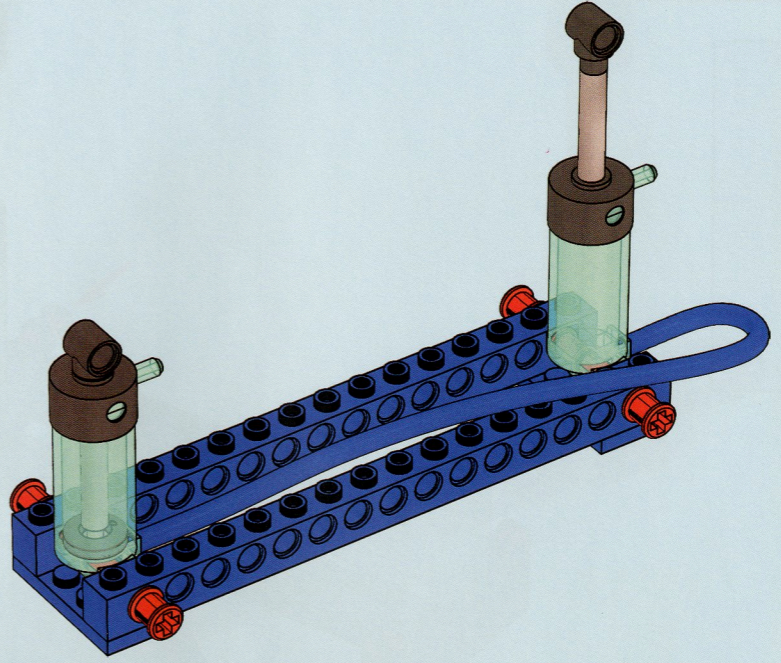

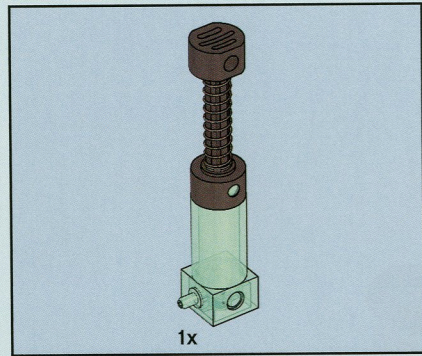
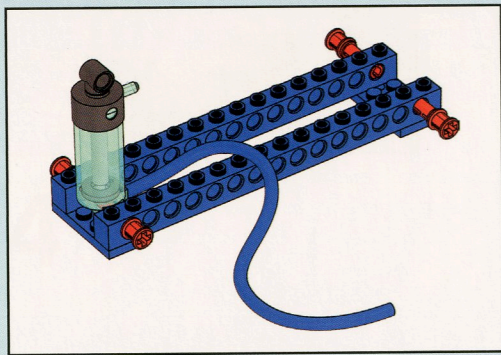

6

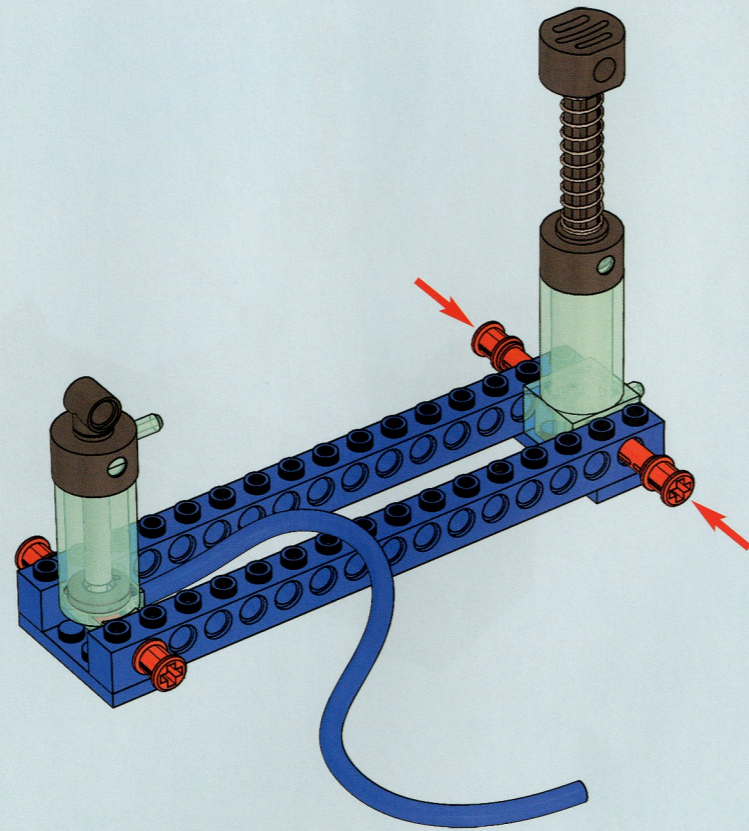

7

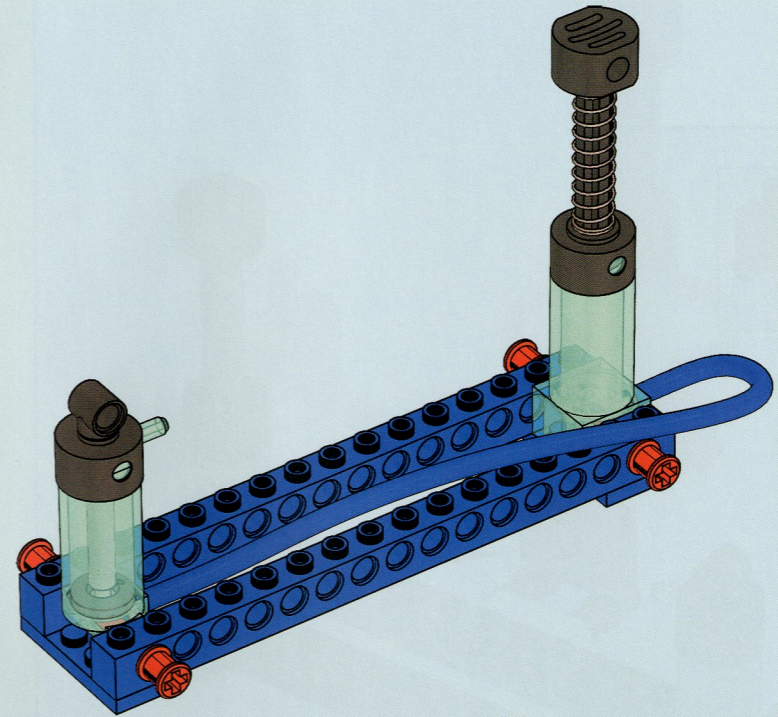

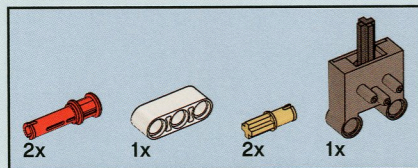
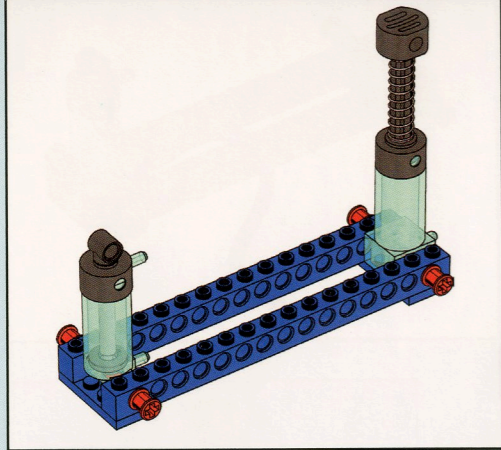

8

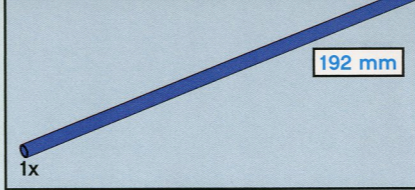
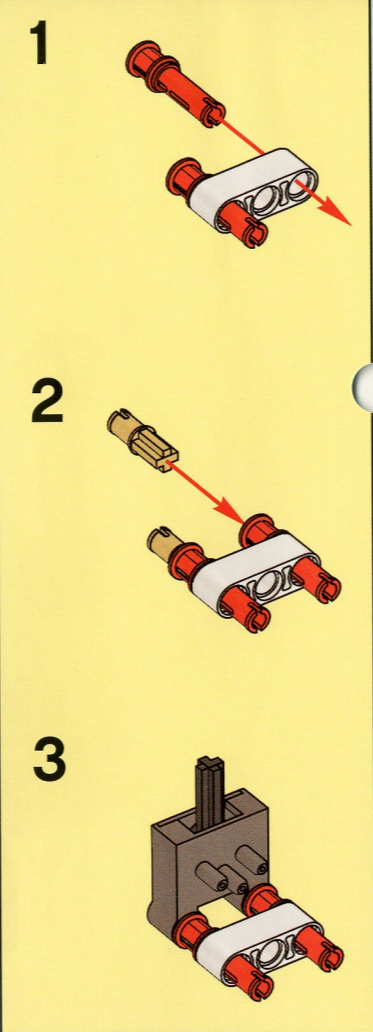
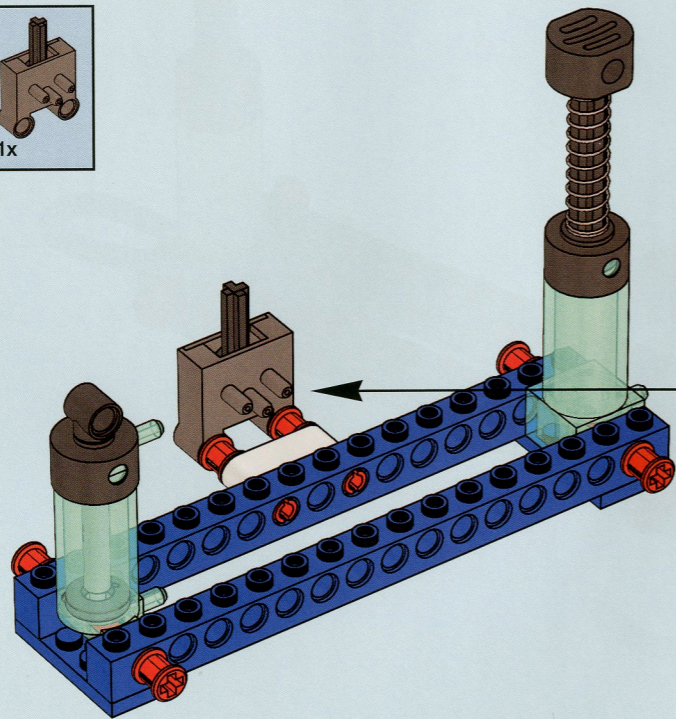

9

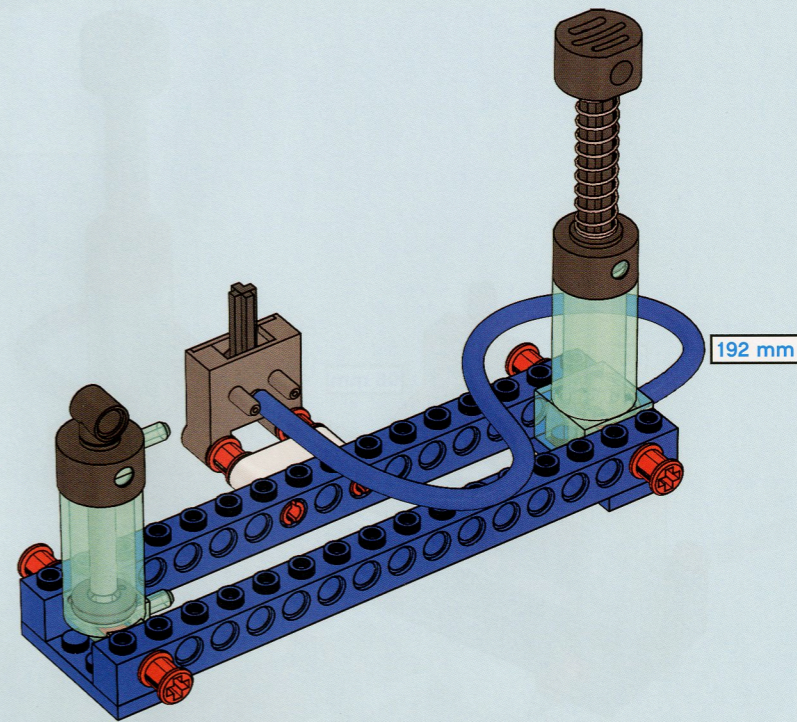

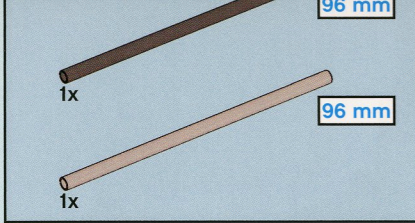

10

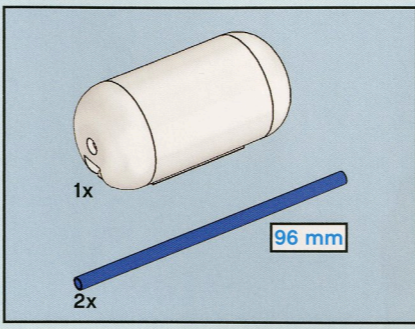
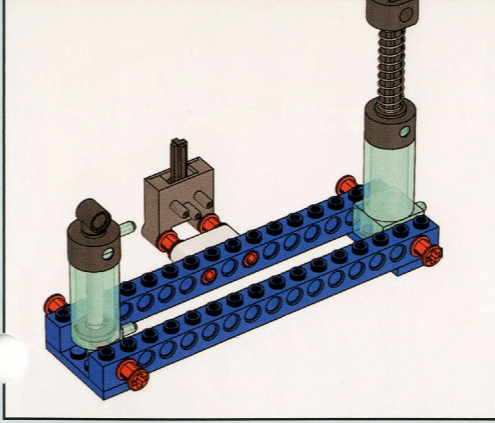
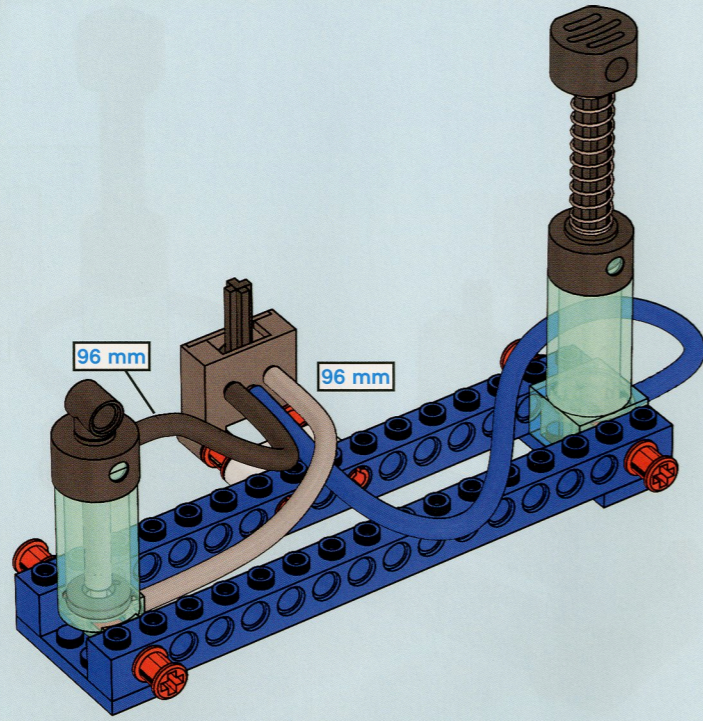

11

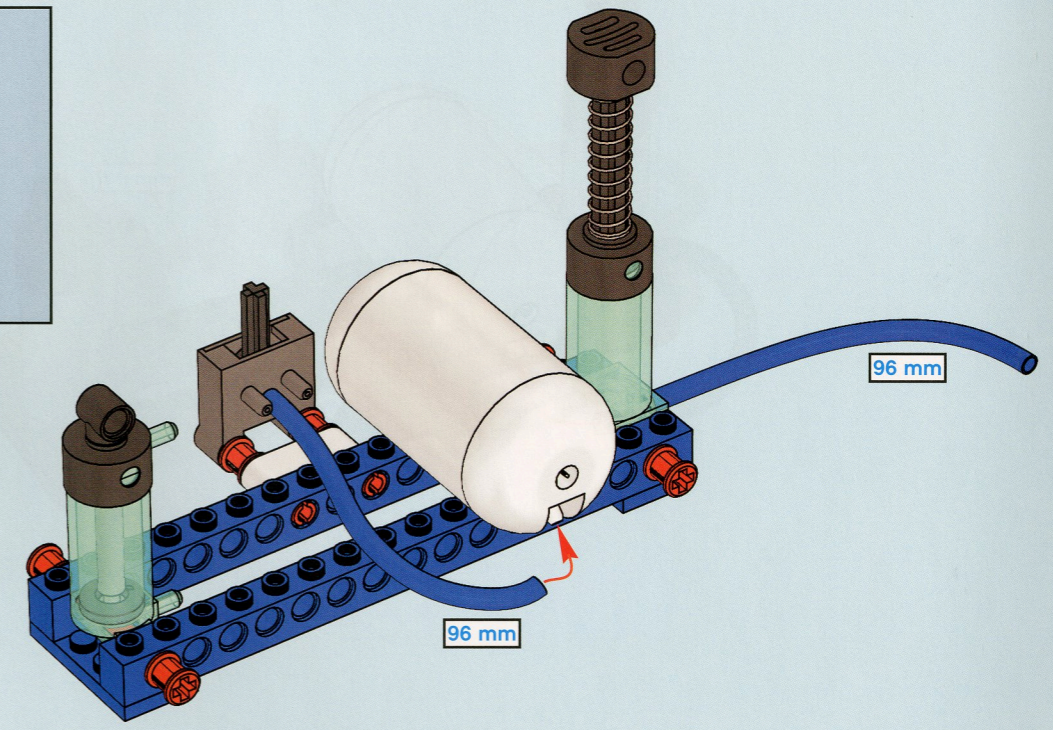

12

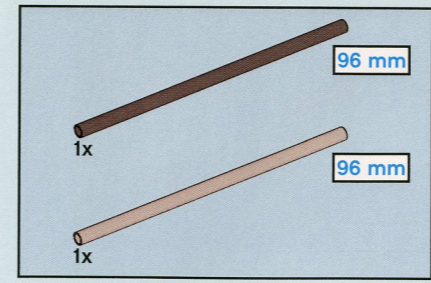
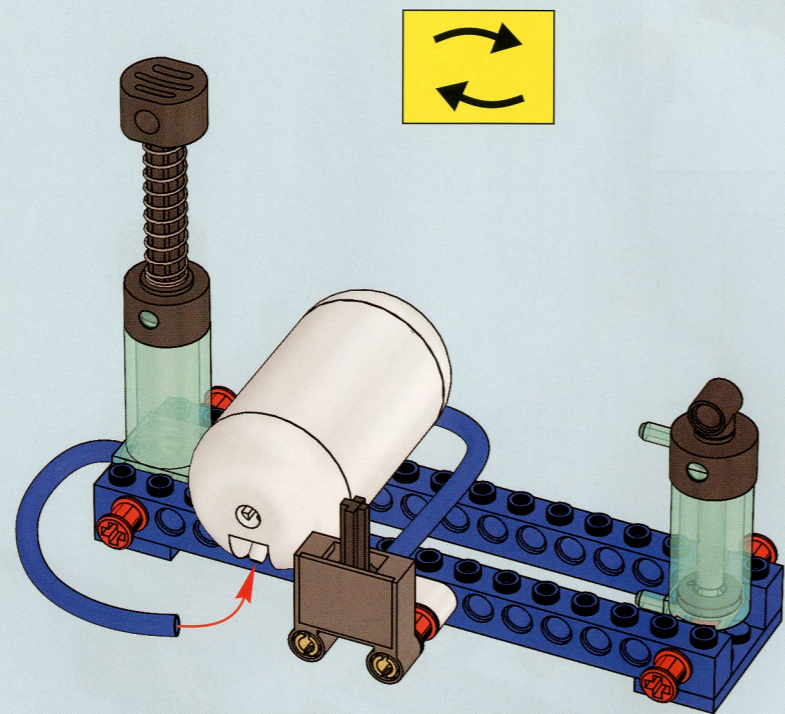

13

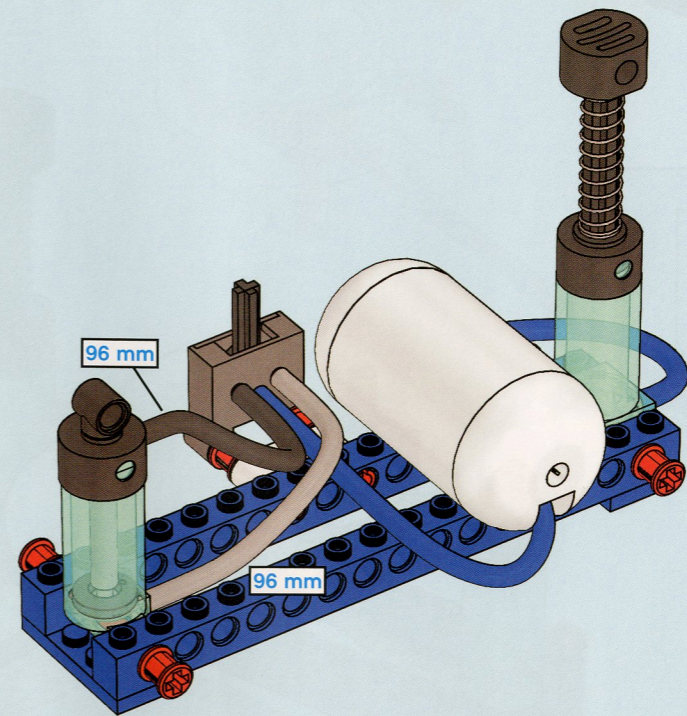



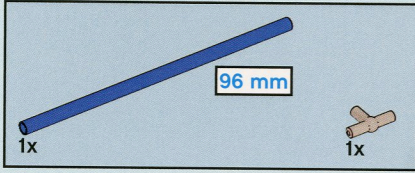
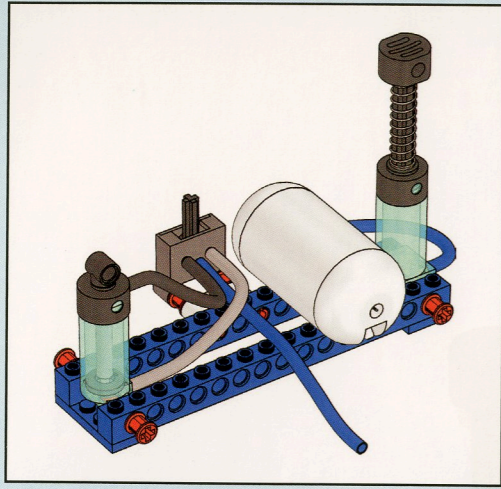

14

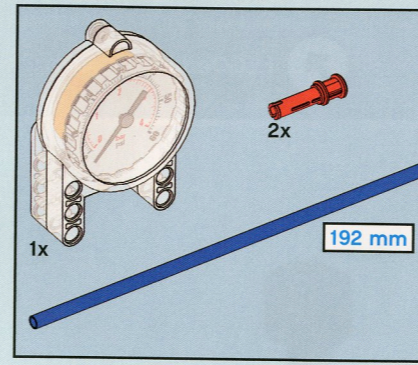
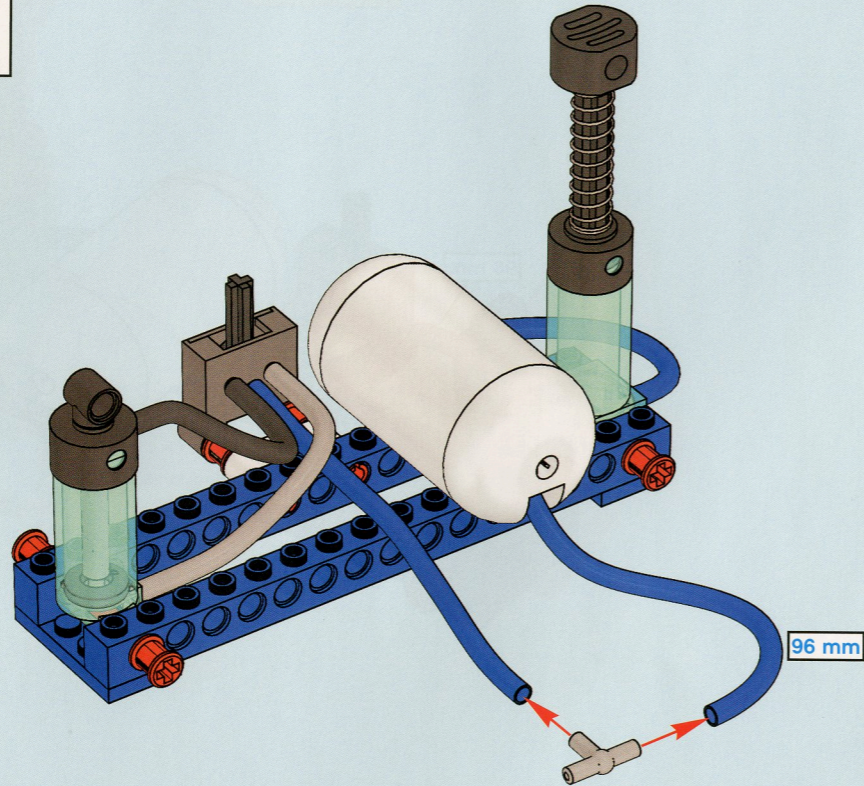

15

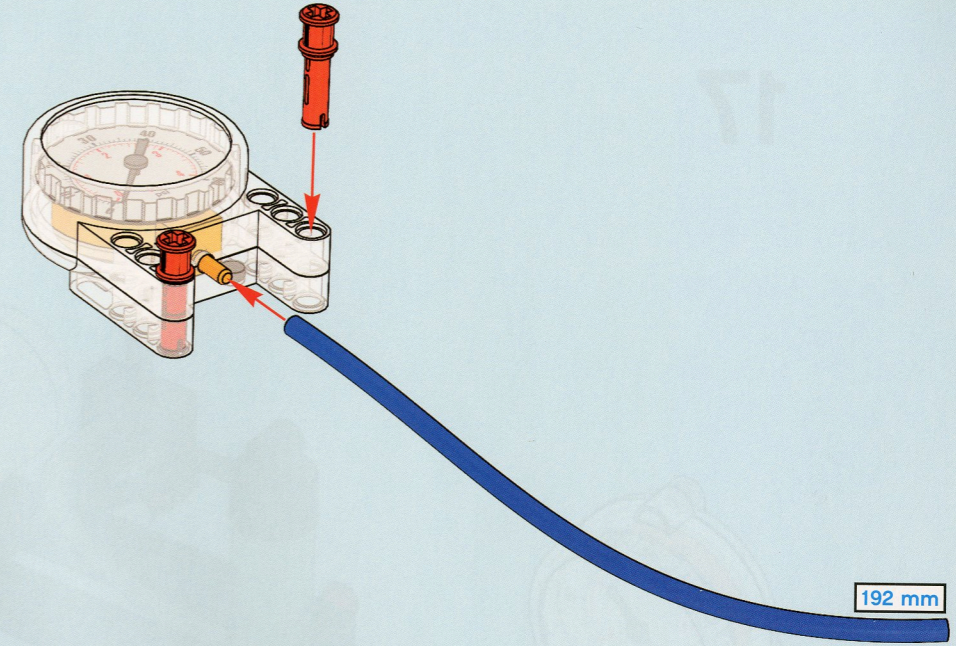

16

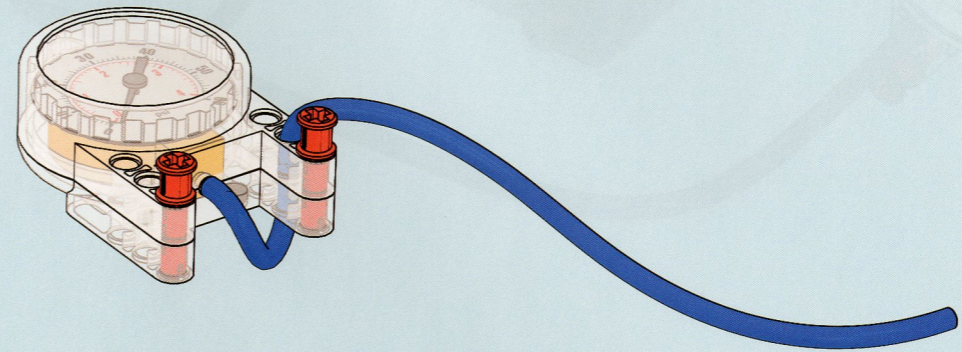

17

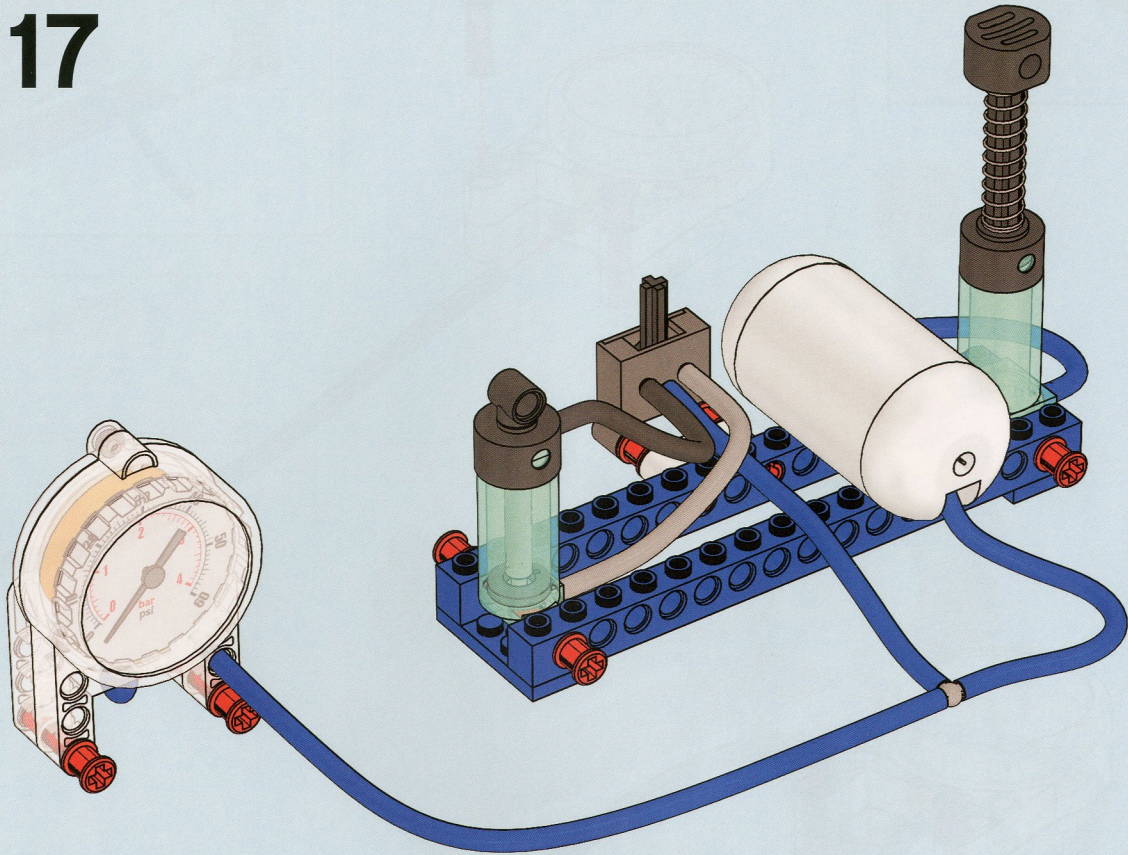

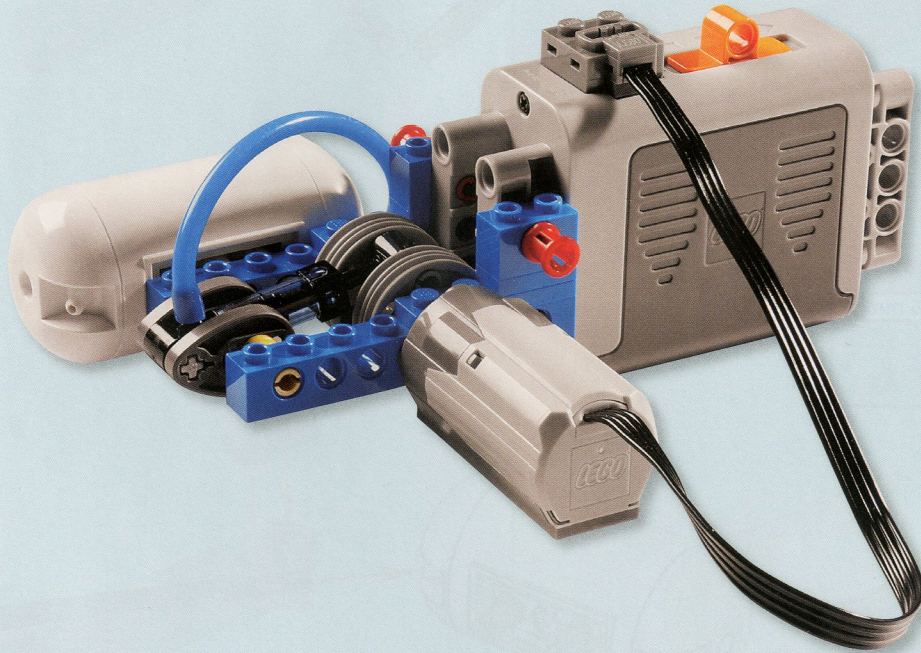

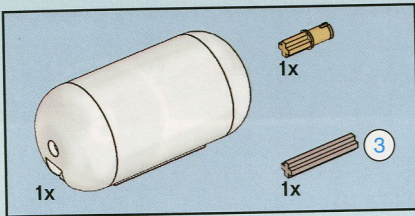

1

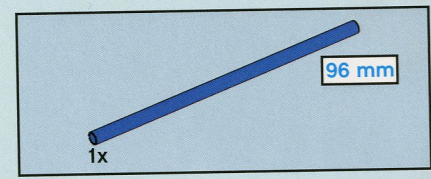
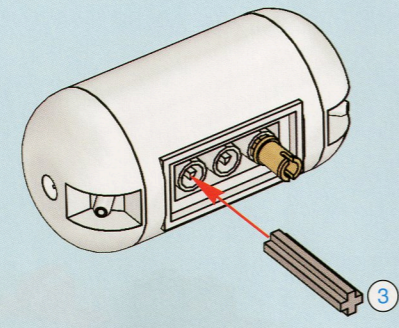
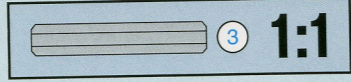

2

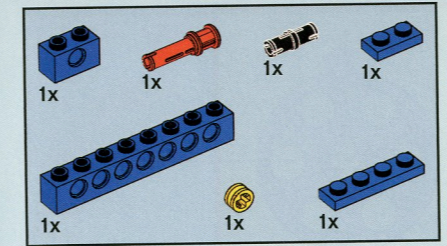
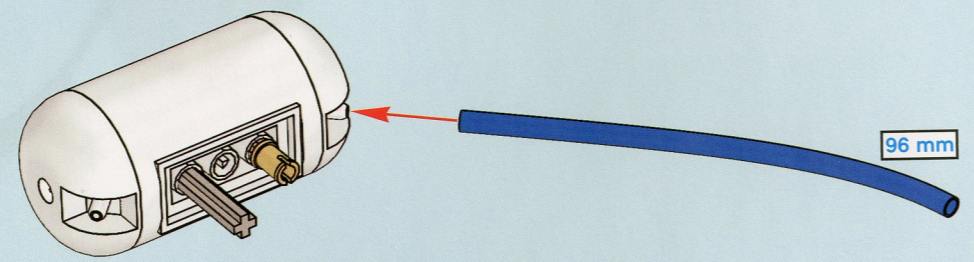

3

1

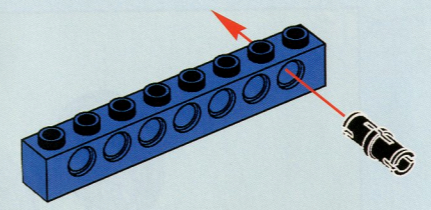

2

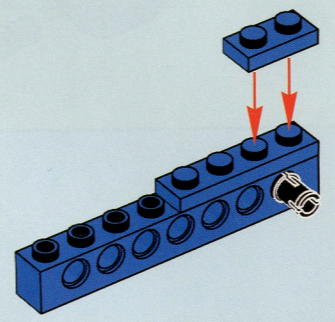

3

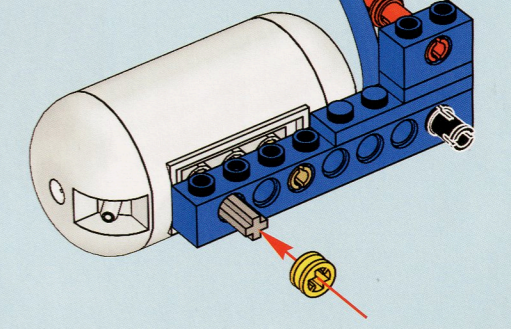
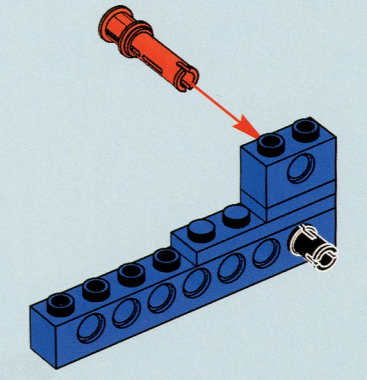

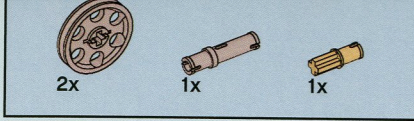

4

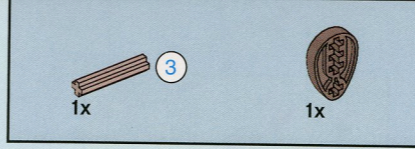
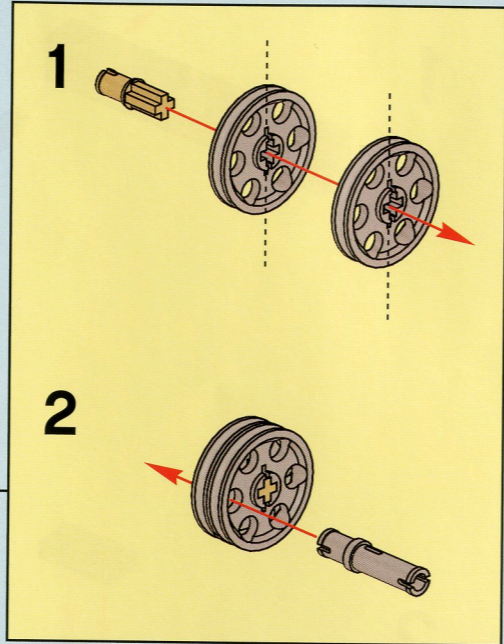
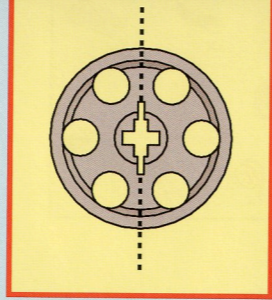
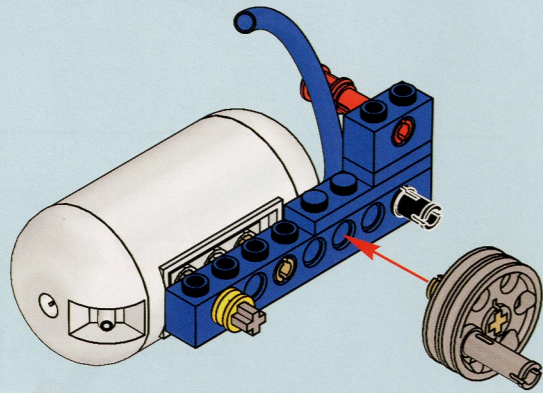

5

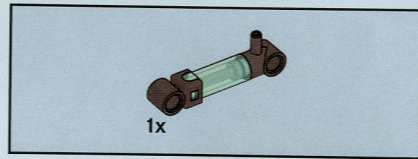
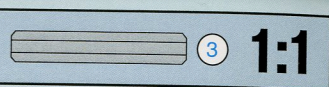
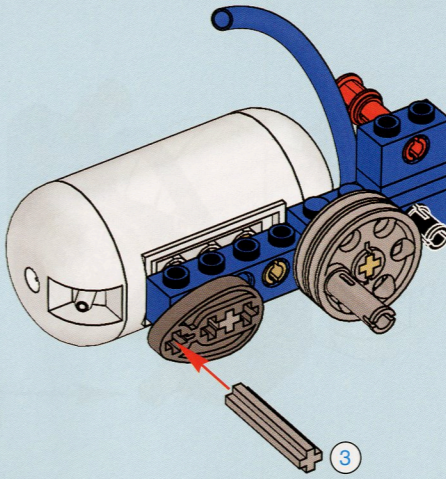

6

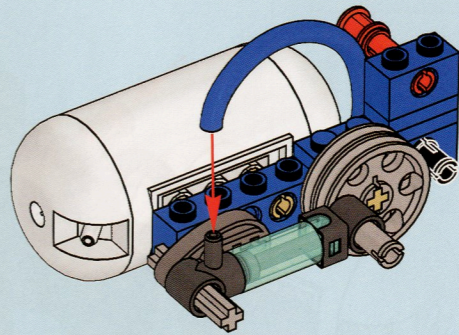

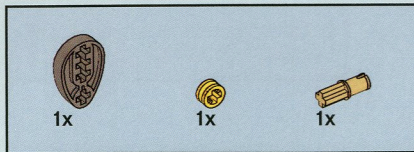

7

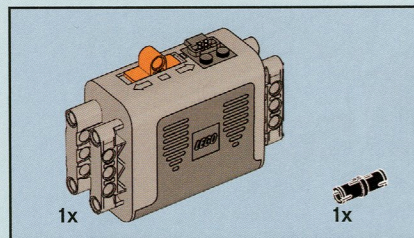
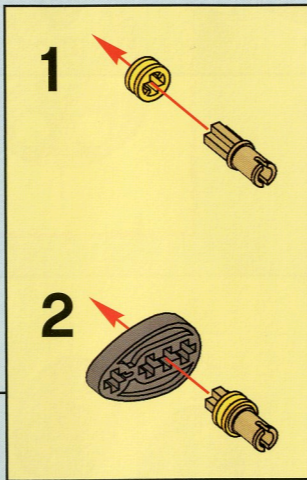
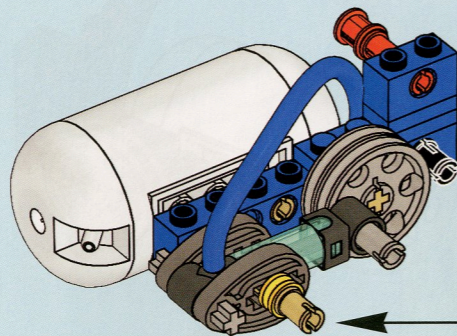

8

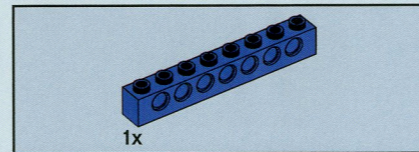
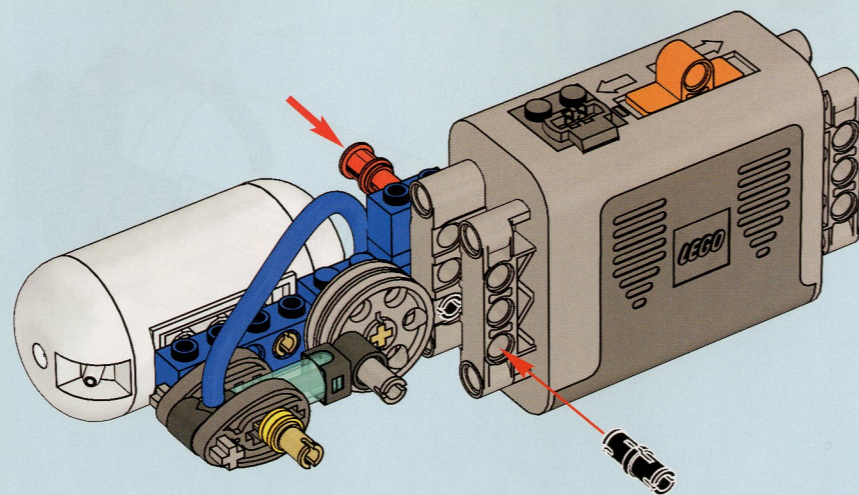

9

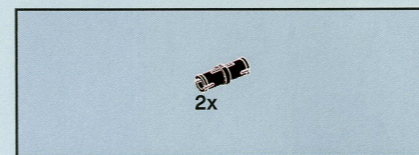
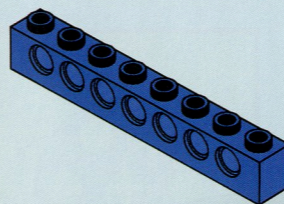

10

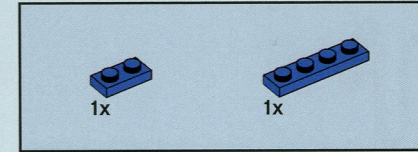
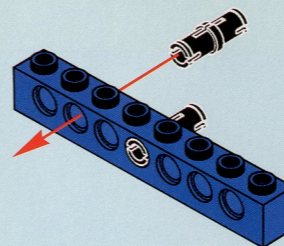

11

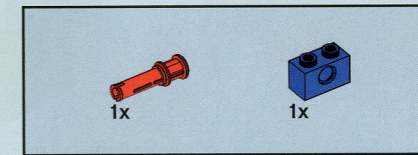
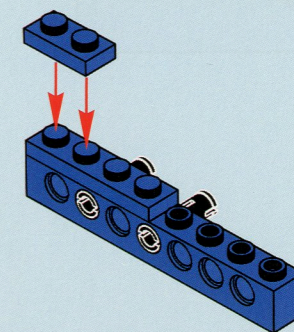

12

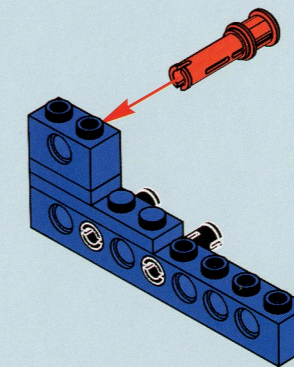

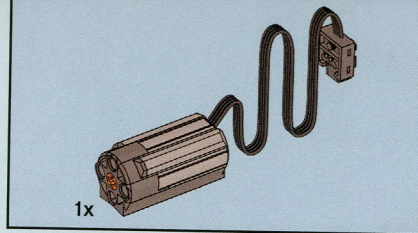

13

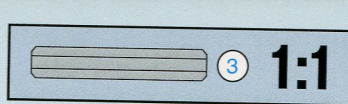
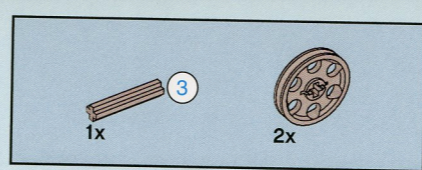
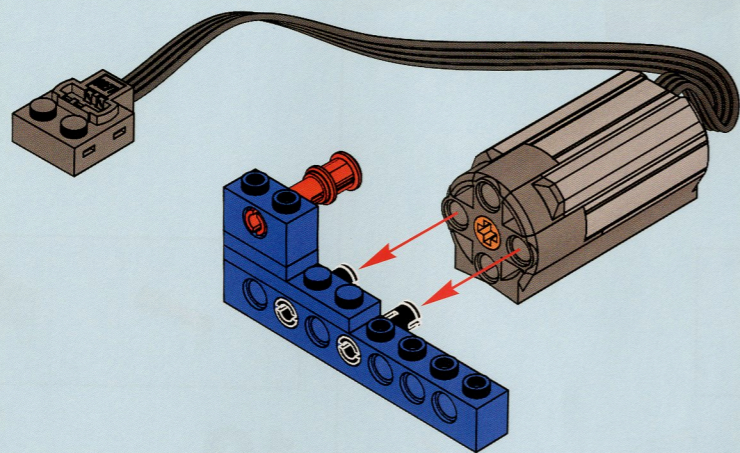

14

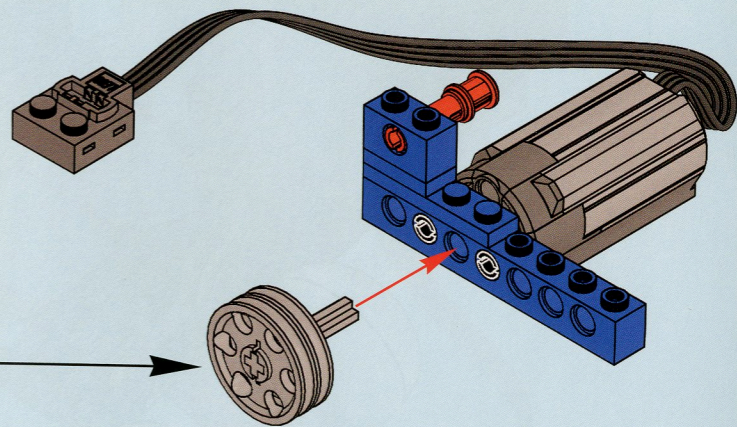
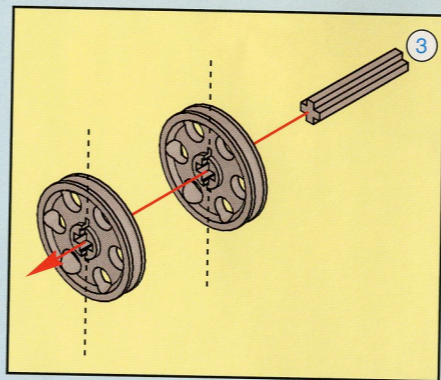
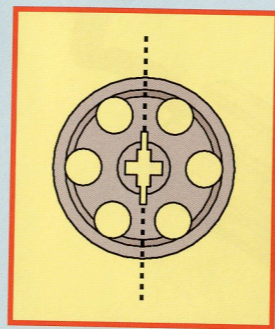

15

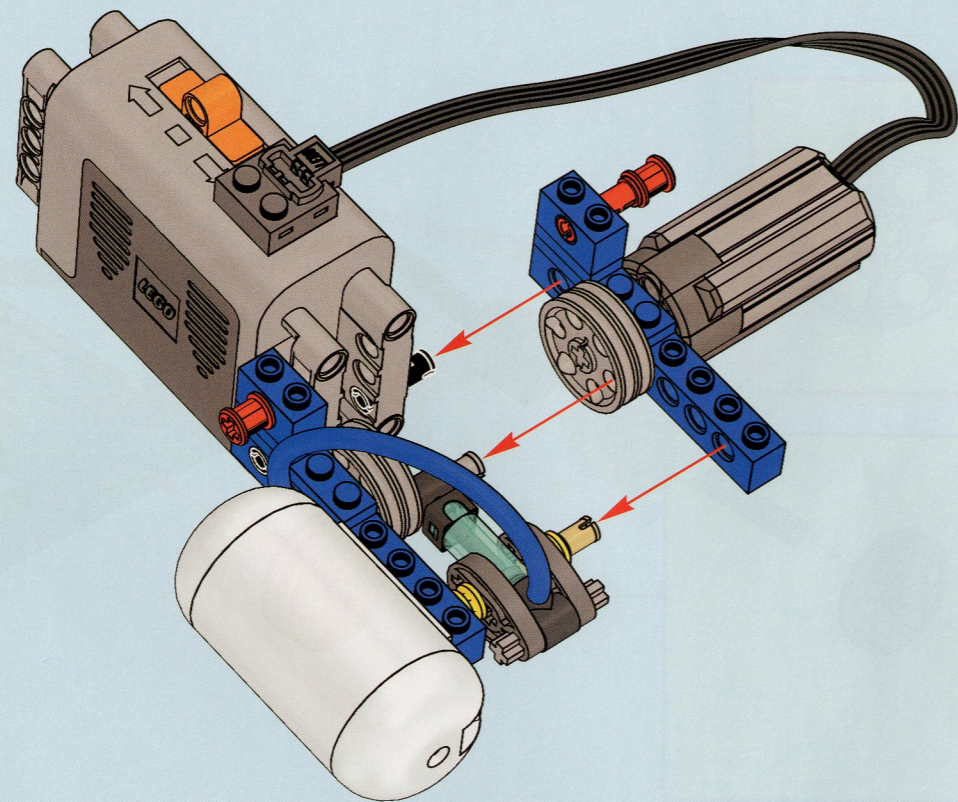

16

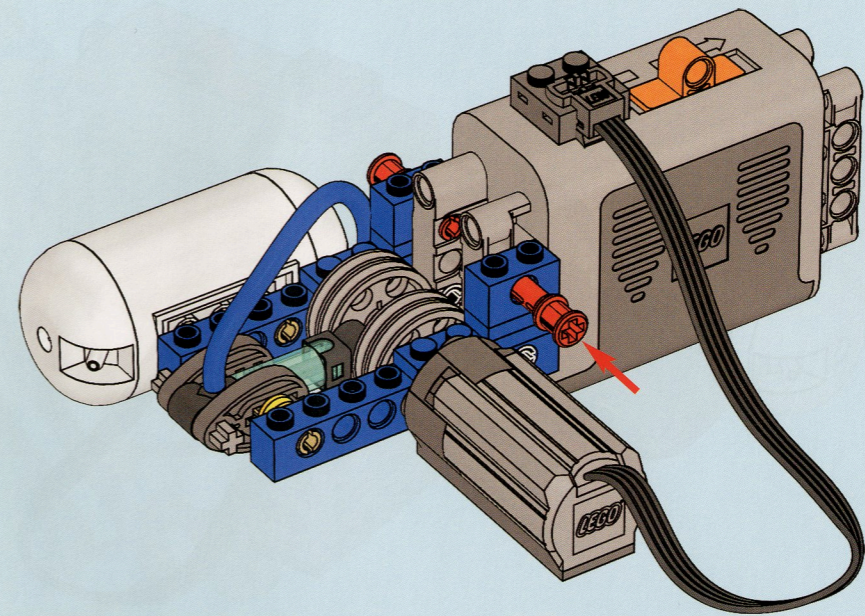



17

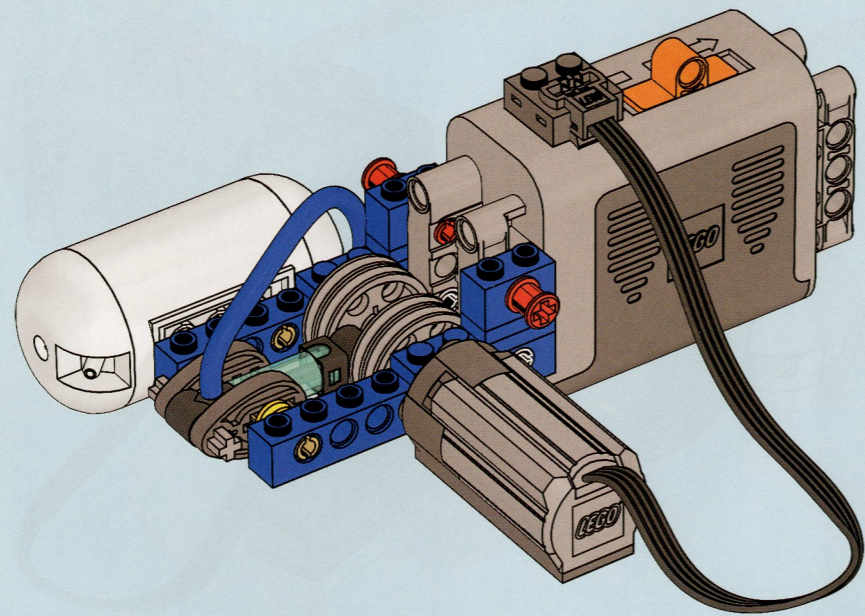

18

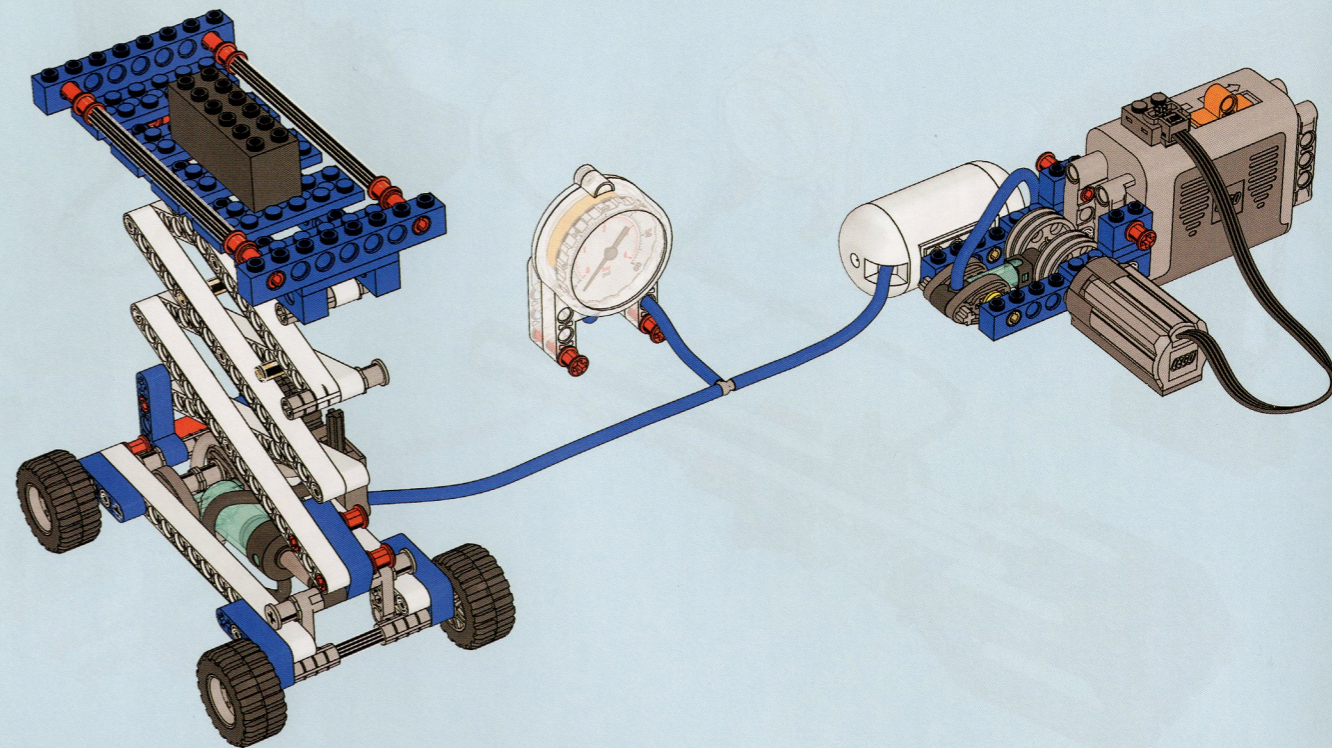

19

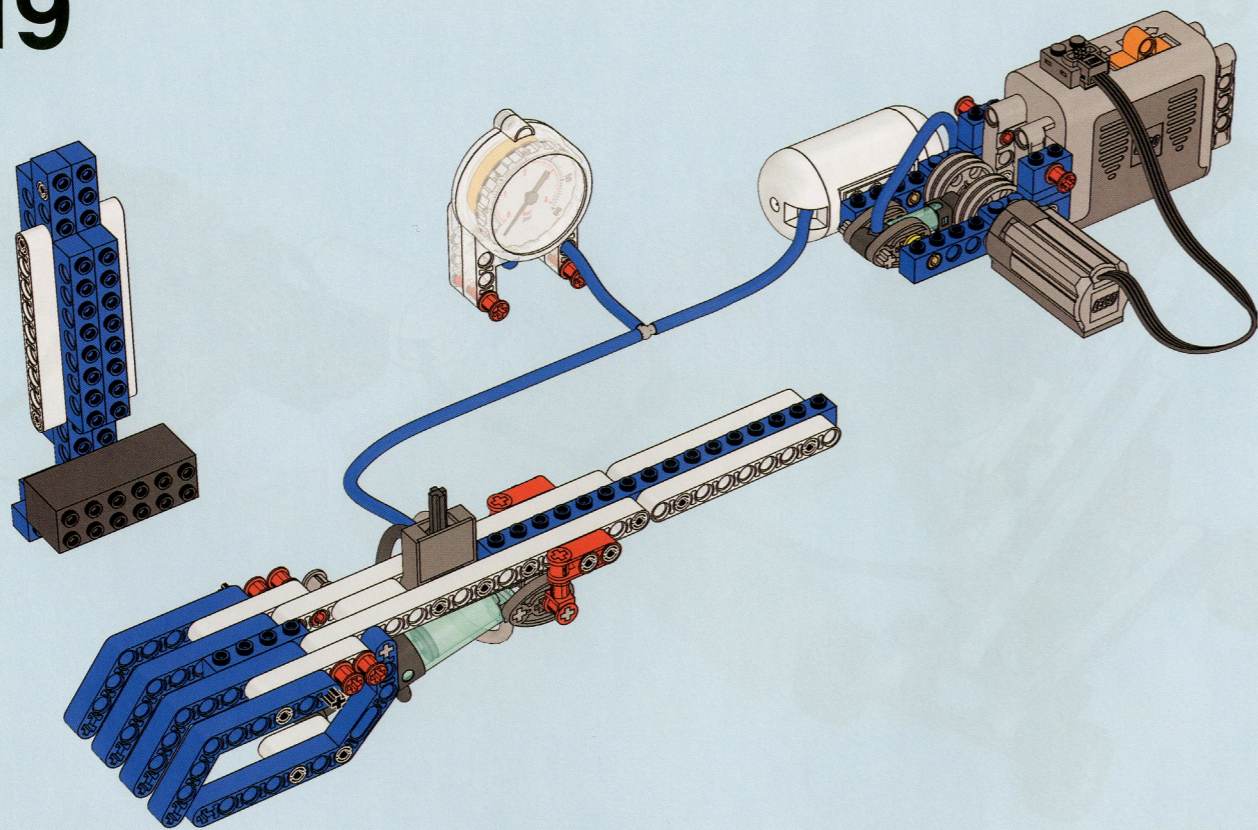

20

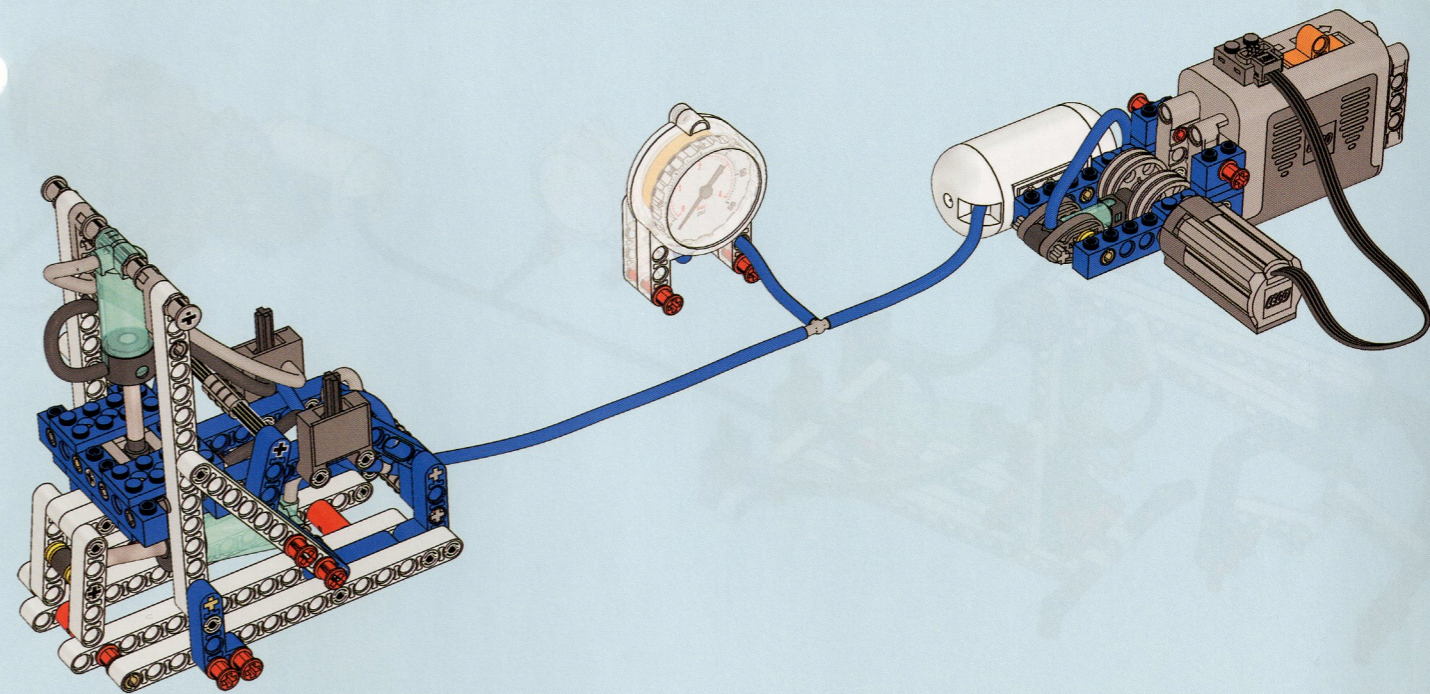

# 21

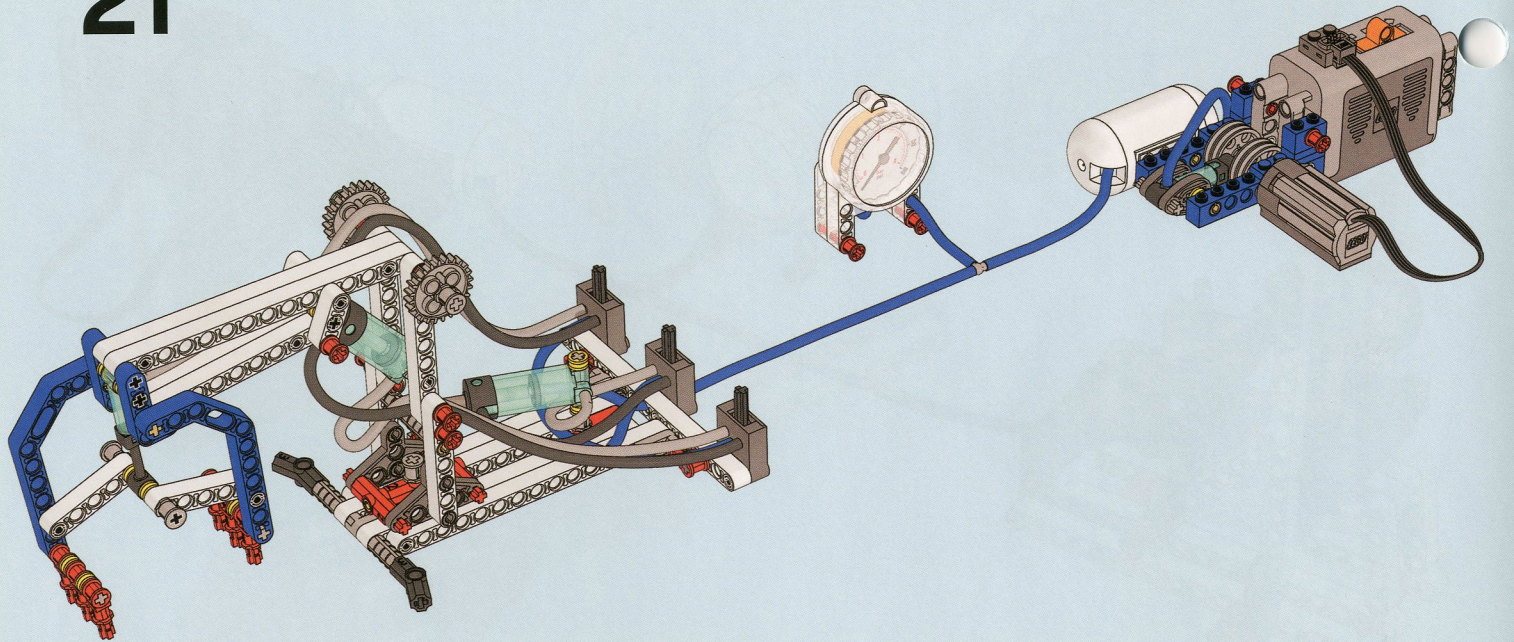

# Curiosity Rover

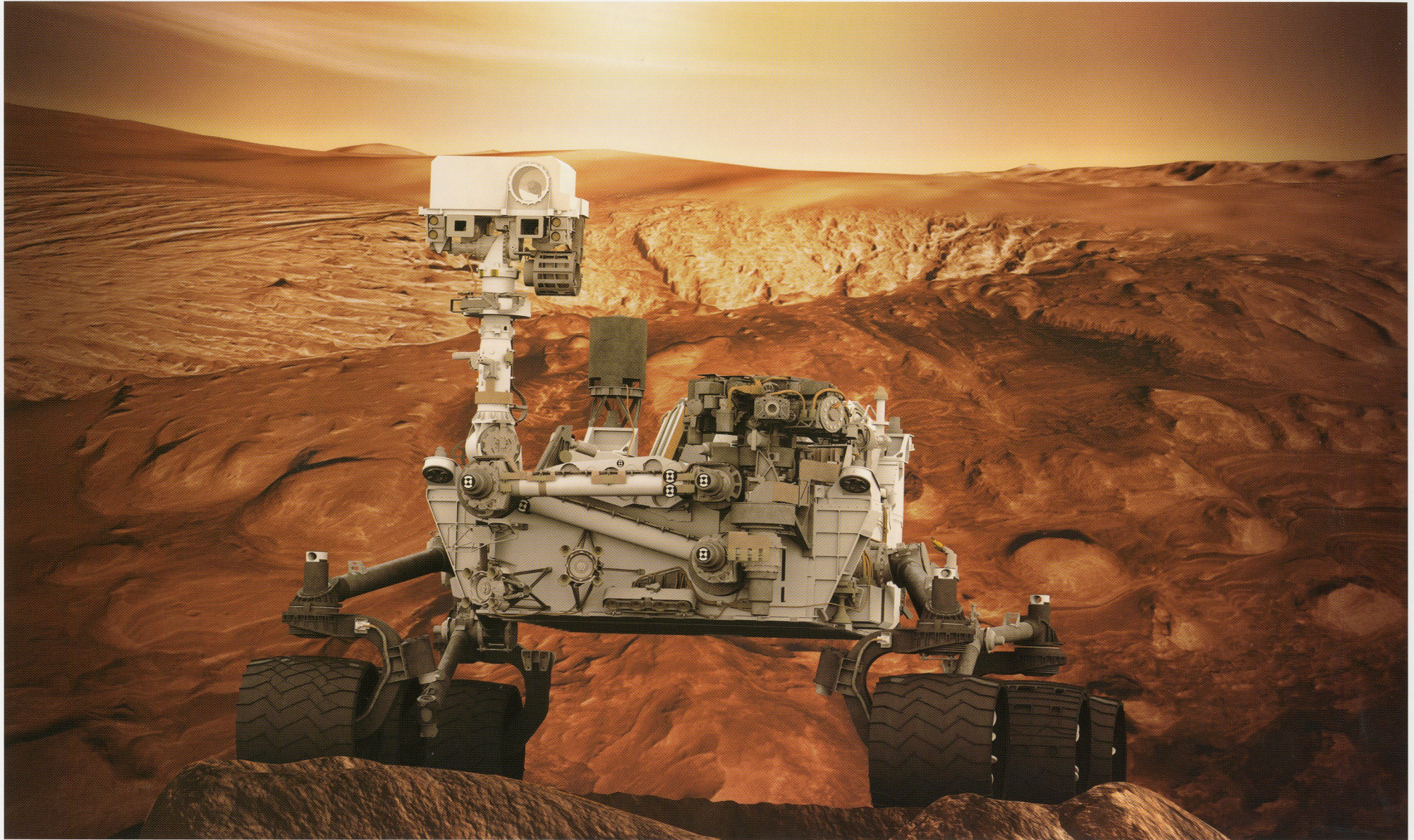

Mars Science Laboratory (MSL)

# Mars Science Laboratory/Curiosity

## Seeking Signs of Life

NASA's Mars Exploration Program has been created to conduct the long-term robotic exploration missions of Mars, the Red Planet. Mars Science Laboratory (MSL) is the next mission intended to unlock the history of Mars. The heart of MSL is a mobile robotic rover, appropriately named *Curiosity*, designed to conduct an in-depth investigation of Mars' past or present ability to sustain microbial life. *Curiosity* is larger and can travel farther than *Spirit* and *Opportunity*, the Mars Exploration Rovers that began exploring Mars in 2004. *Curiosity* will carry the biggest, most advanced suite of instruments for scientific studies ever sent to the martian surface.

The rover will analyze dozens of samples scooped from the soil, drilled from rocks, and pulled from the atmosphere. The record of Mars' climate and geology is essentially "written in the rocks and soil"—in their formation, structure, and chemical composition. *Curiosity*'s on-board laboratory will study the samples and the local geologic setting in order to detect chemical building blocks of life (e.g., forms of carbon) on Mars and assess what the martian environment was like in the past, addressing the fundamental question, was Mars ever a habitat for microbial life.

## Objectives

- Assessing biological potential of the martian site
- Characterizing geology and geochemistry
- Investigating the role of water, atmospheric evolution and climate
- Characterizing the spectrum of surface radiation

## Gale Crater—Curiosity Landing Site

Gale Crater is a fascinating place to explore because of the mountain of layered materials in the middle—a mound about three times as high as the rim of the Grand Canyon (5 km/3 miles) on Earth! The layers tell a story about what Mars was like in the past, perhaps spanning much of the early history of the Red Planet. Studies from orbit have revealed that the layers have different minerals, that usually from in water, depending on their height. Near the bottom of the mound are clay minerals. Above the clay-bearing layers are layers with minerals containing sulfur and oxygen. These different layers represent different environmental histories of Mars.

## Instruments

### Remote Sensing:

**Mastcam**—Color and telephoto imaging, video, atmospheric opacity

**ChemCam**—Chemical composition, remote micro-imaging

### Contact Instruments (Arm):

**MAHLI**—Hand-lens color imaging

**APXS**—Chemical composition

### Analytical Laboratory (Rover Body):

**SAM**—Chemical and isotopic composition, including organics

**CheMin**—Mineralogy

### Environmental Characterization:

**MARDI**—Descent imaging

**REMS**—Meteorology/UV

**RAD**—High-energy radiation

**DAN**—Subsurface hydrology

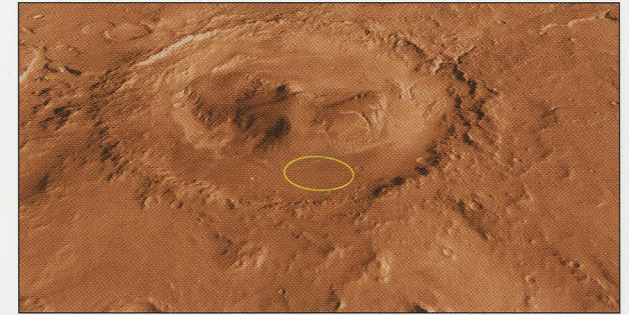

**Gale Crater**—Curiosity Landing Site

*Curiosity* will land at the foot of a layered mountain inside Gale Crater.

For more information about Gale Crater and why NASA has selected this landing site go to [www.nasa.gov/msl](http://www.nasa.gov/msl). To soar over Gale Crater on Mars see the animation at <http://mars.jpl.nasa.gov/msl/multimedia/videos>.

## Launch/Landing Profile

**Launch Date:** Nov 26, 2011,  
10:02 a.m. EST (7:02 a.m. PST)

**Location:** Cape Canaveral Air Force Station, Florida

**Vehicle:** United Launch Alliance Atlas V 541

**Landing Date:** Aug 6, 2012, 1:30 a.m. EDT

## Entry, Descent and Landing

*Curiosity* will make its exciting arrival on the martian surface using a new high-precision entry, descent and landing system. To view an animation of this dramatic landing go to <http://mars.jpl.nasa.gov/msl/multimedia/videos>.

For more information about MSL, visit [www.nasa.gov/msl](http://www.nasa.gov/msl), <http://mars.jpl.nasa.gov/msl>



NASA MISSION:  
IDAHO TECH  
MARS ROVER CHALLENGE

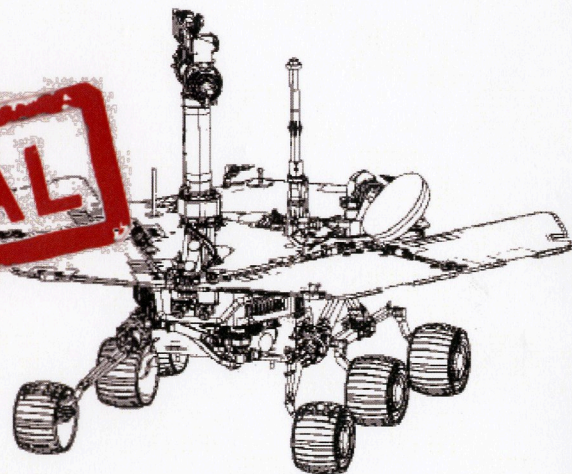

9641

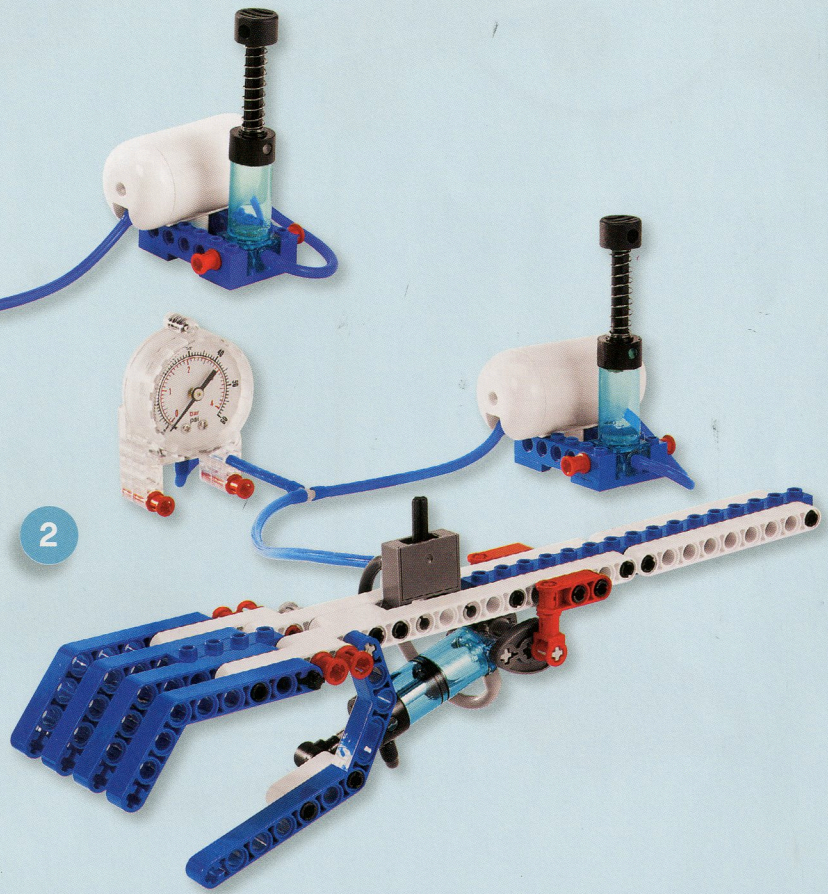
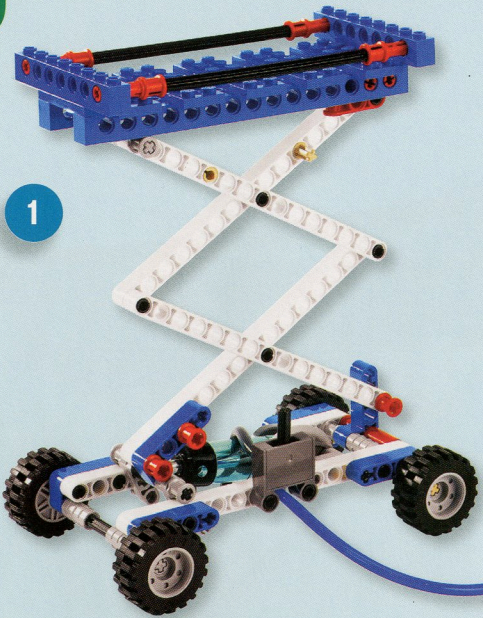

1A

2A

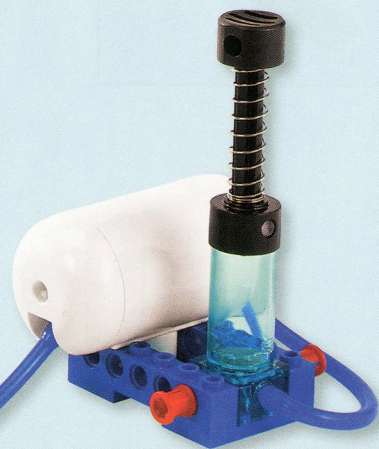
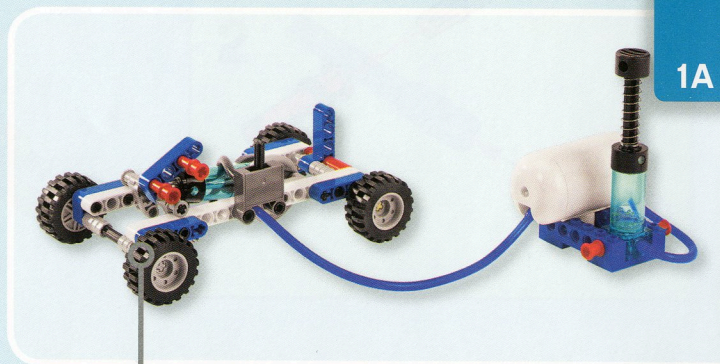
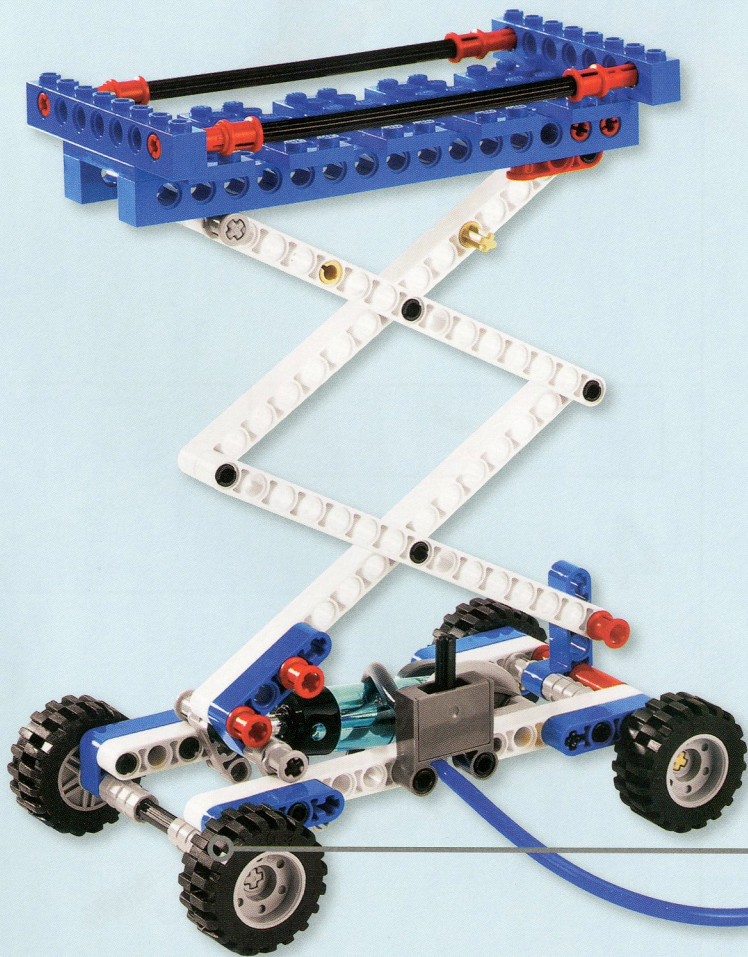





1

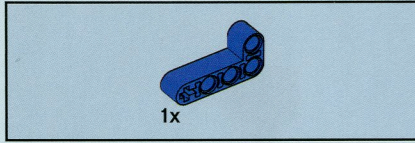
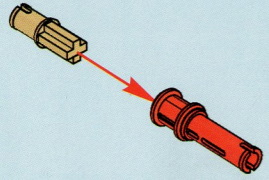

2

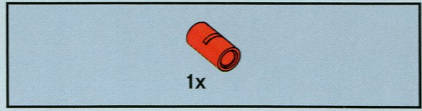
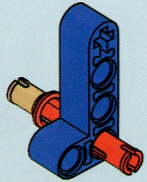

3

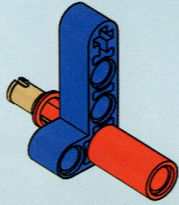

4

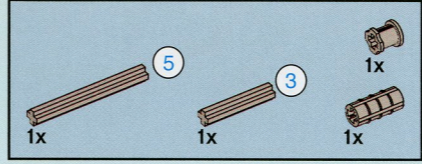
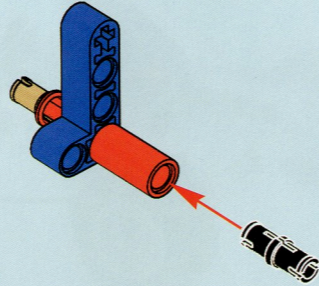

5

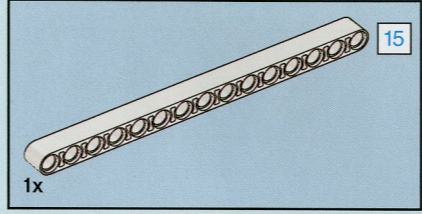
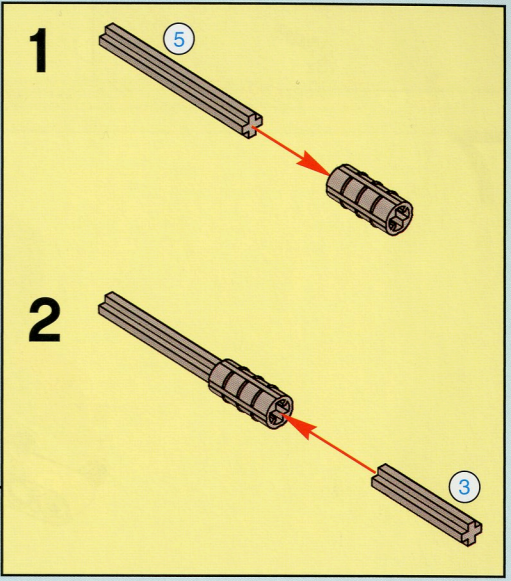
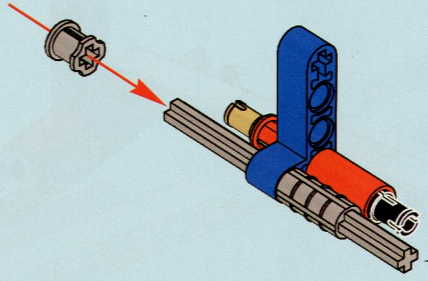

6

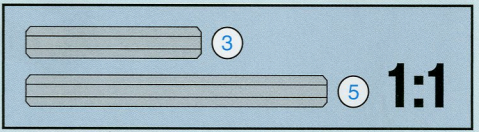
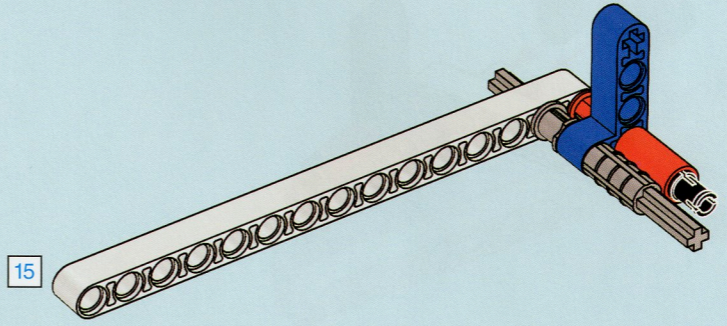



7

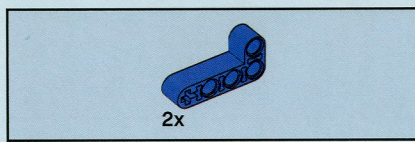
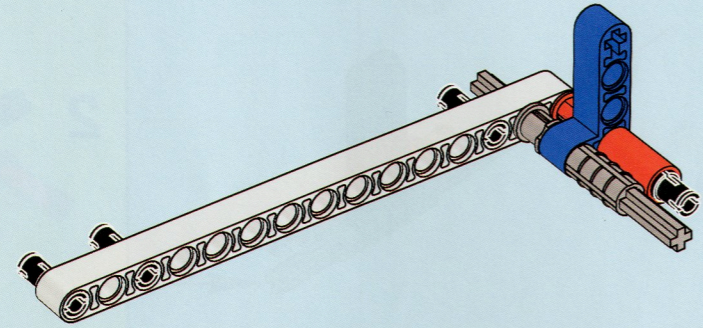

8

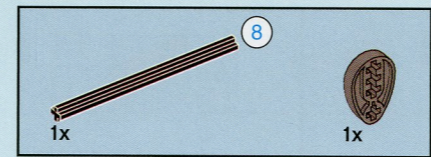
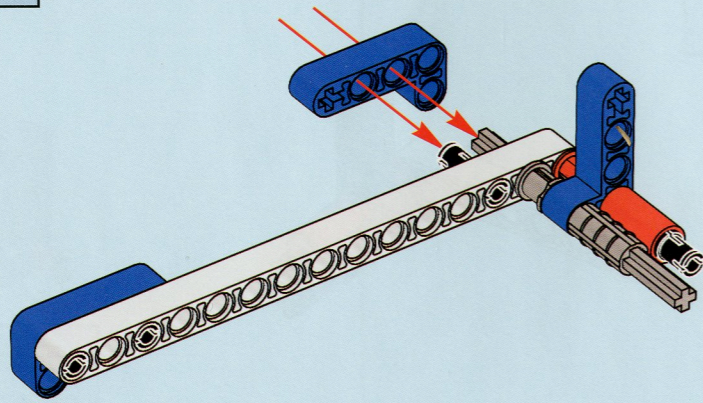

9

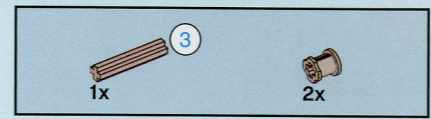
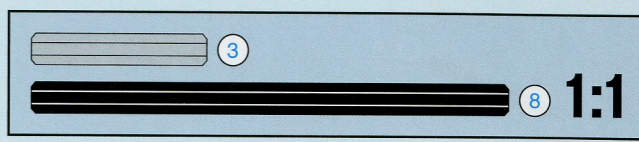
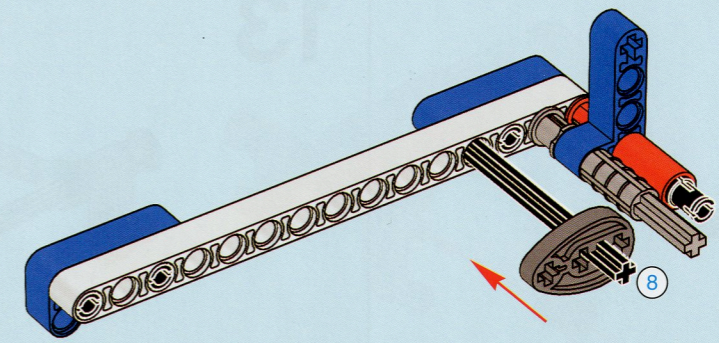

10

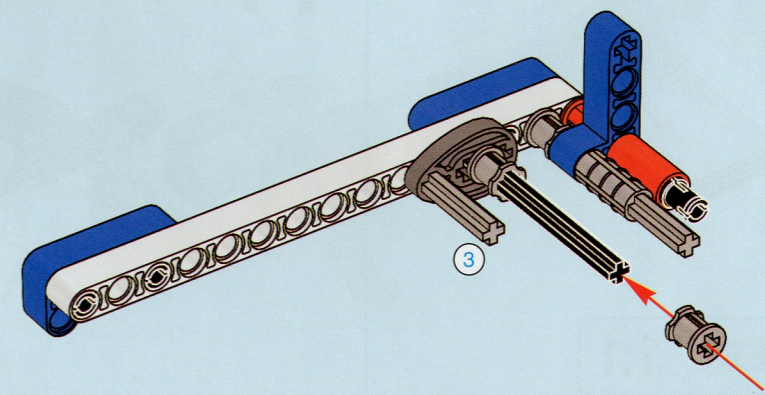

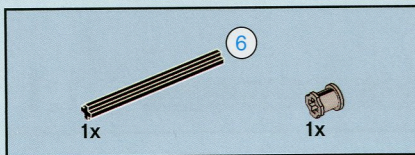

11

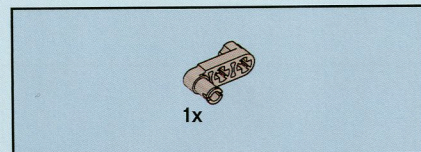
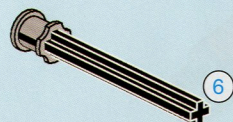

12

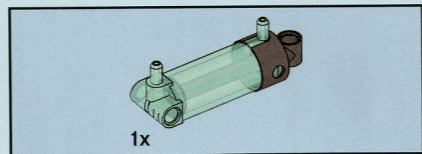
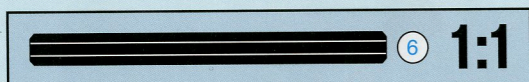
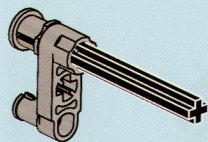

13

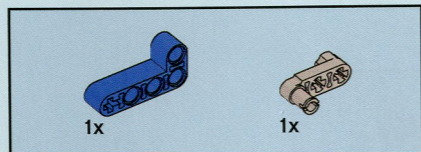
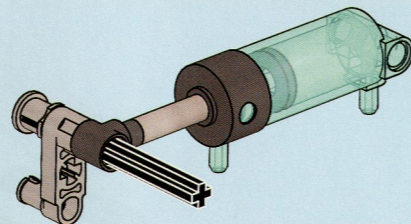

14

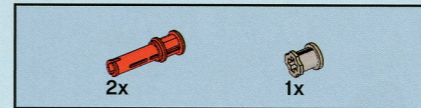
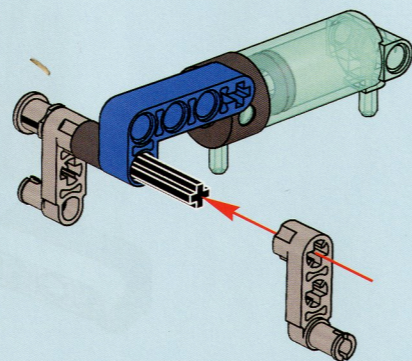

15

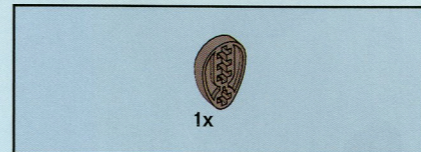
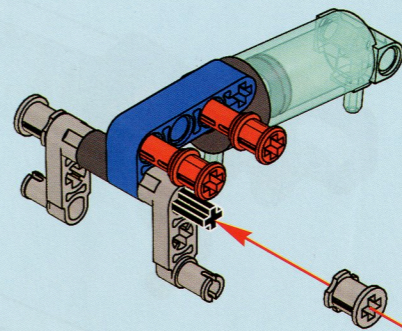

16

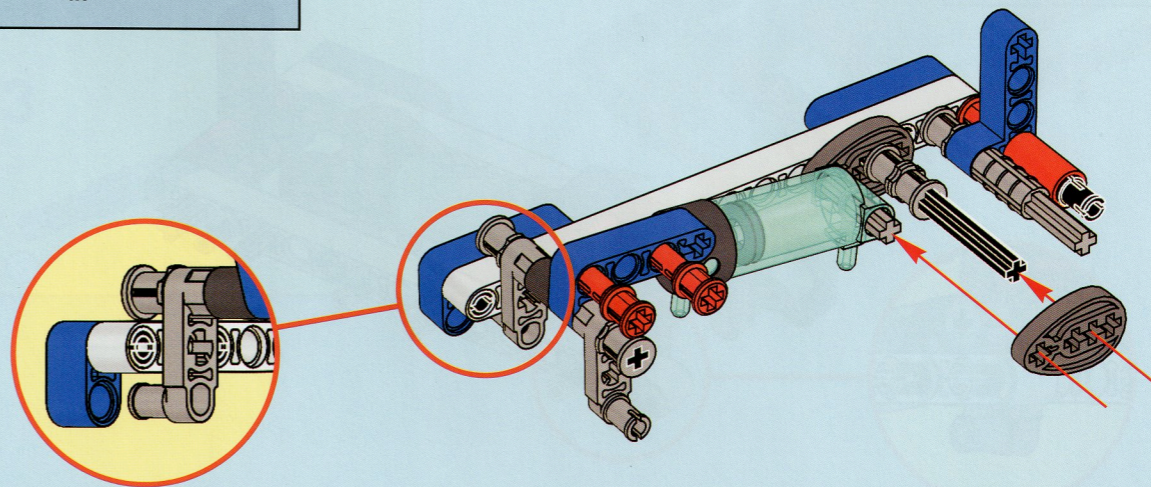

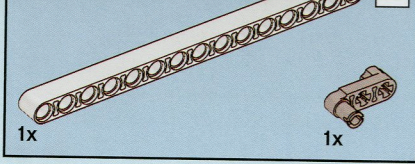

17

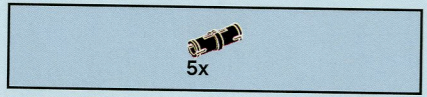
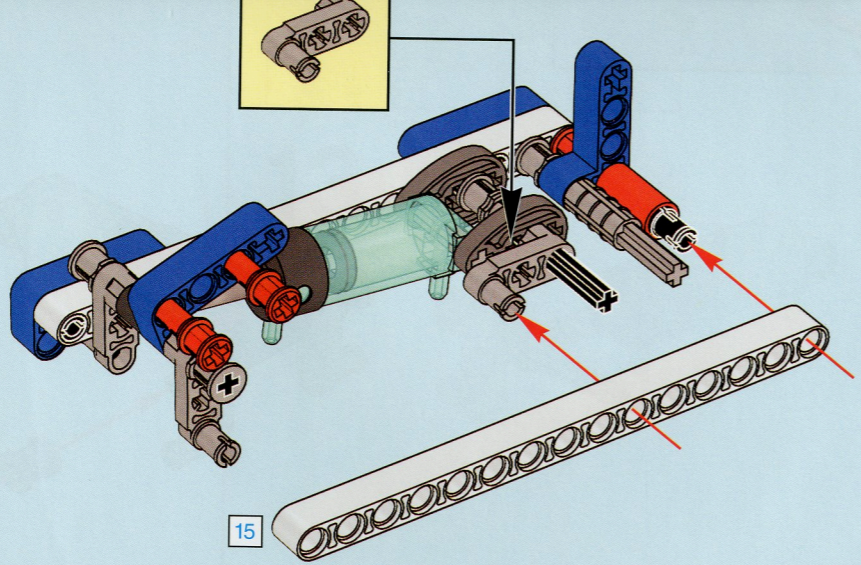

18

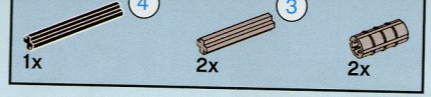
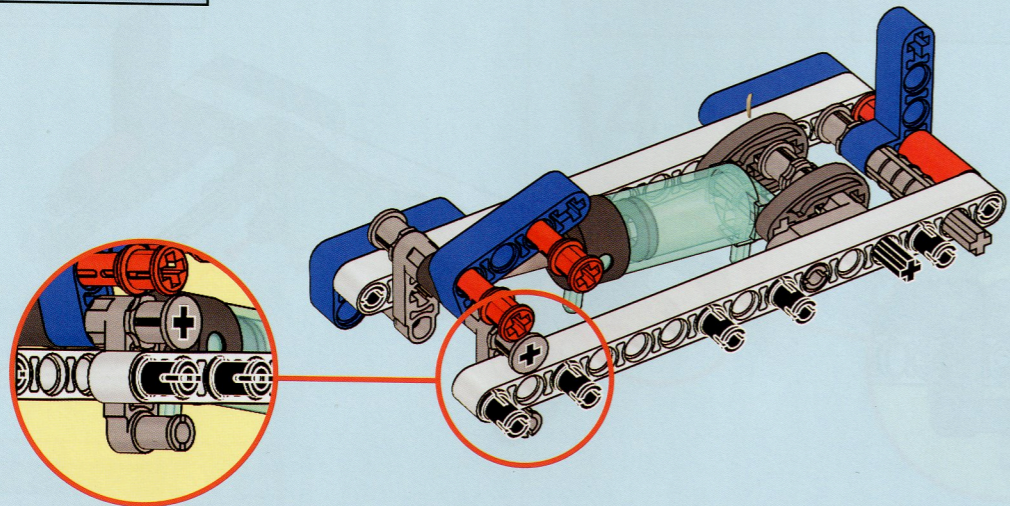

19

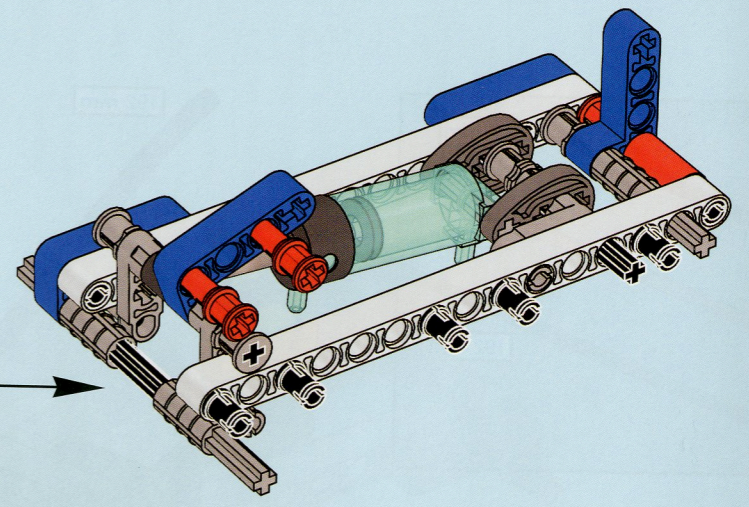
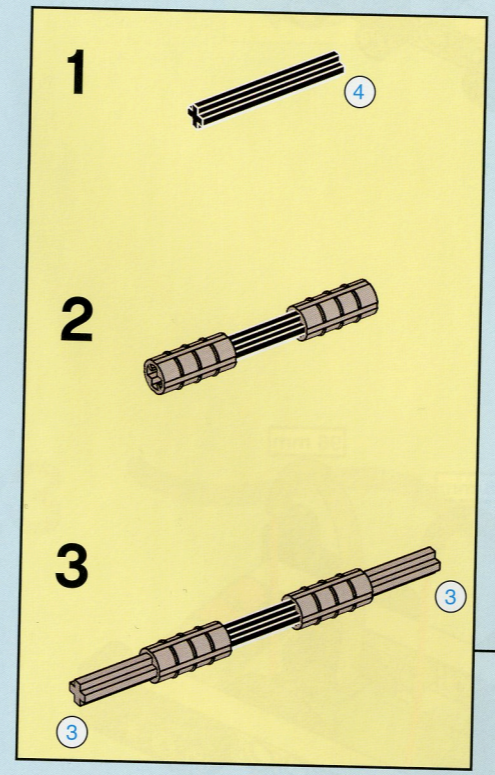
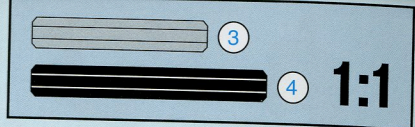

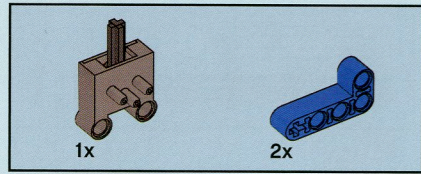

20

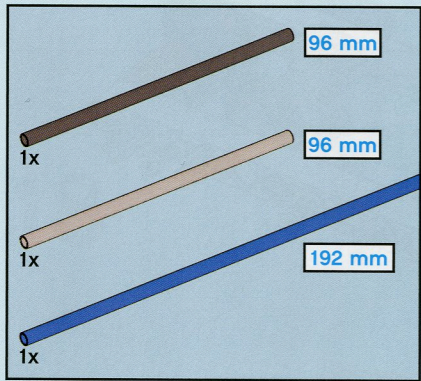
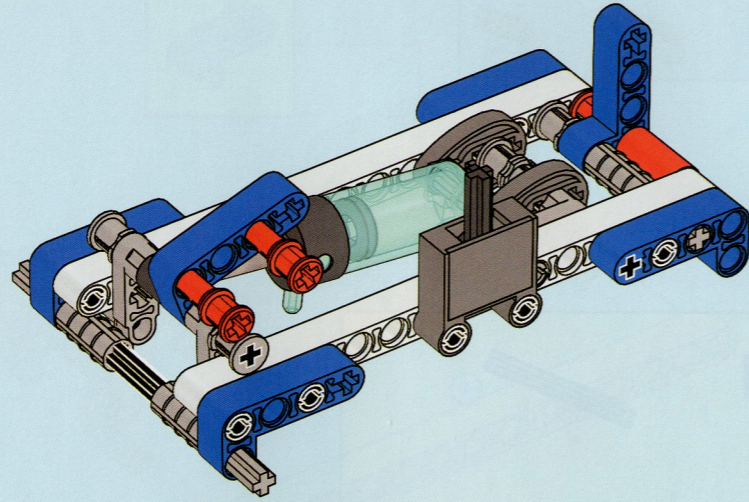

21

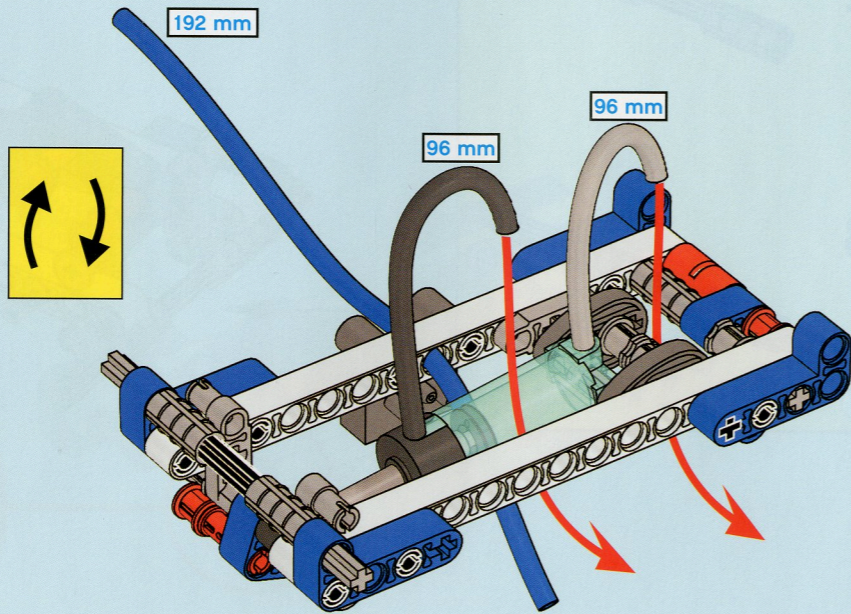

22

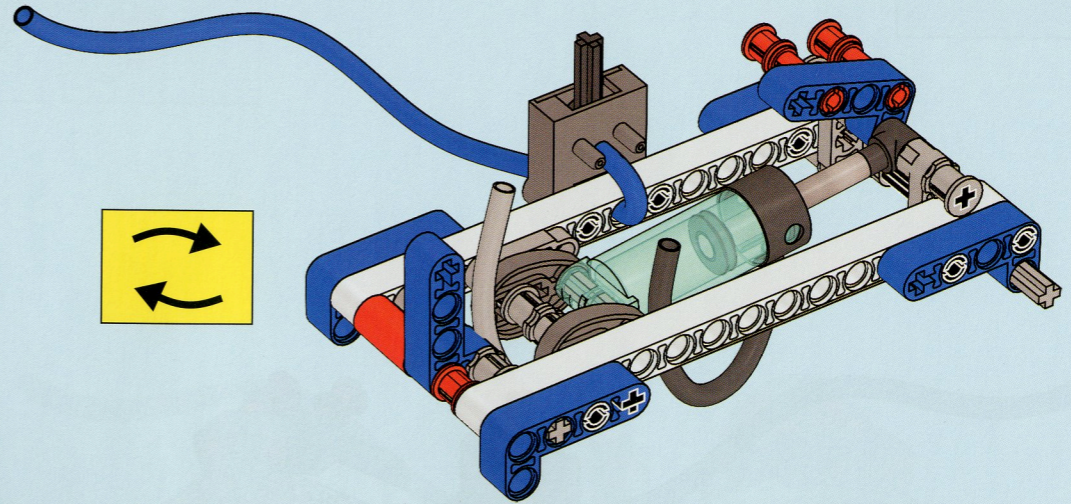
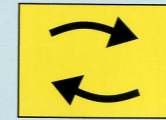

23

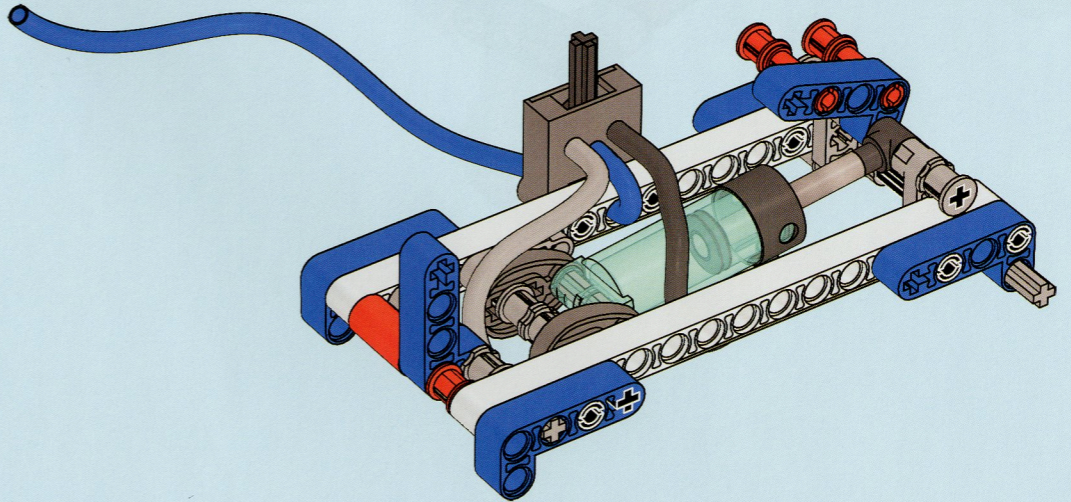

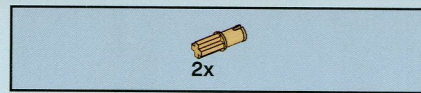

24

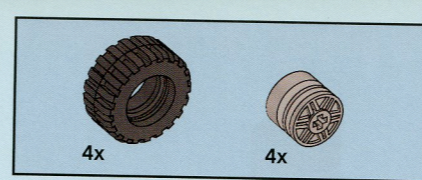
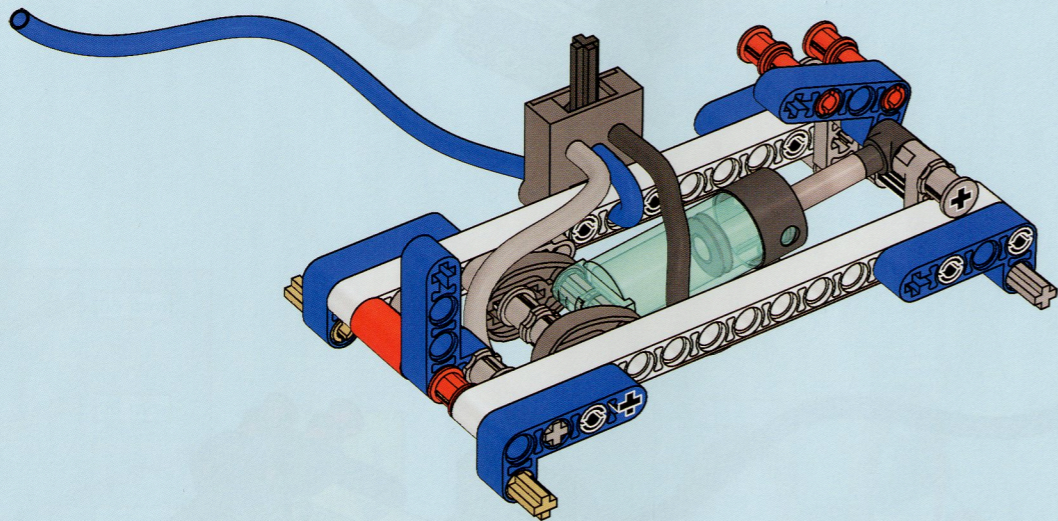

25

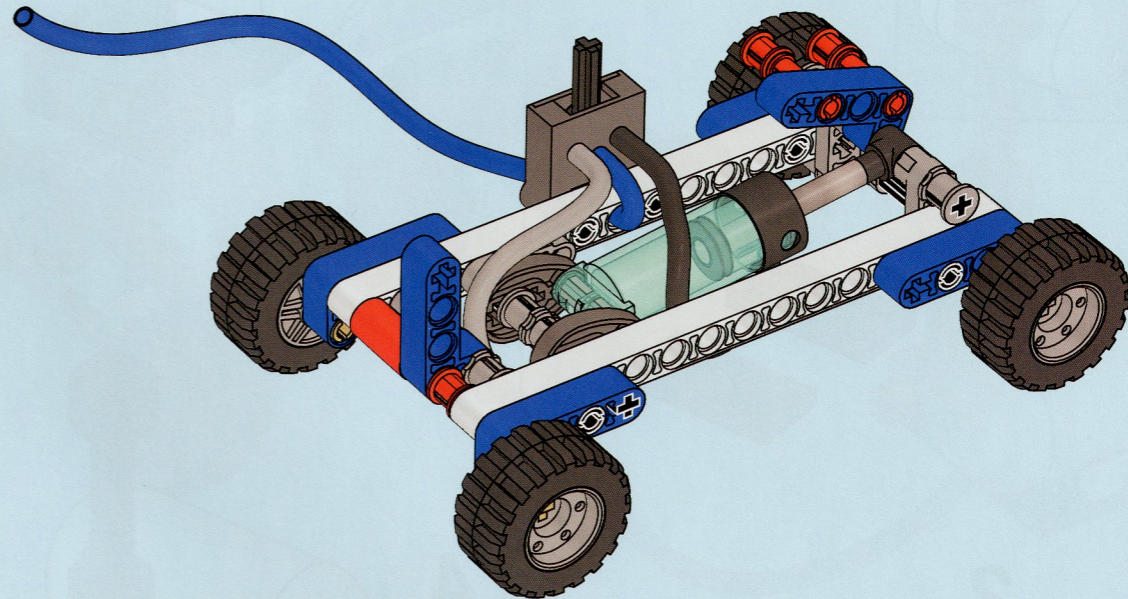

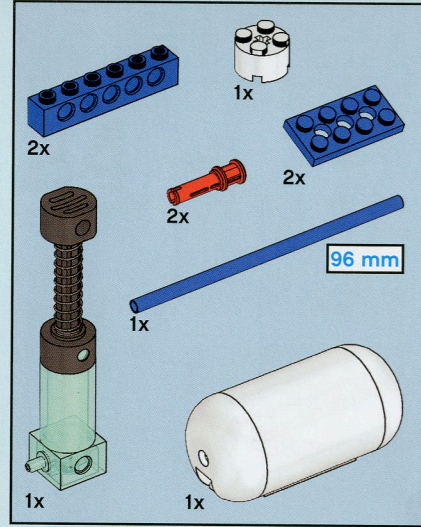

26

1

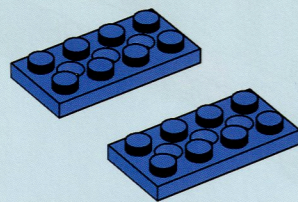

2

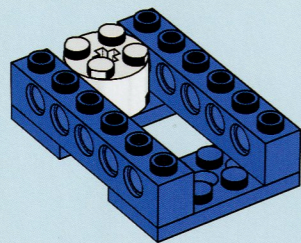

3

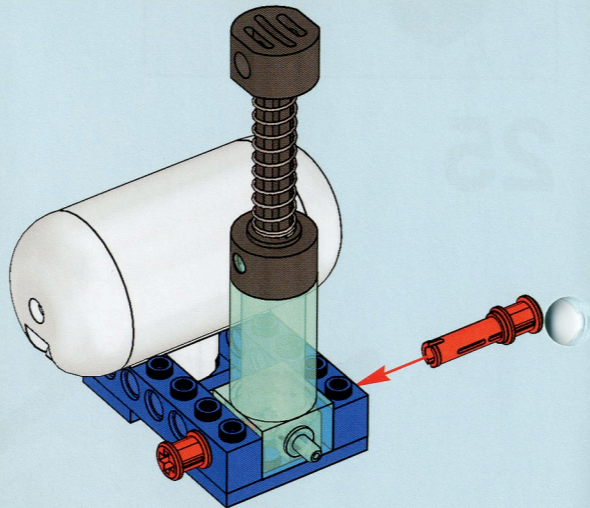

4

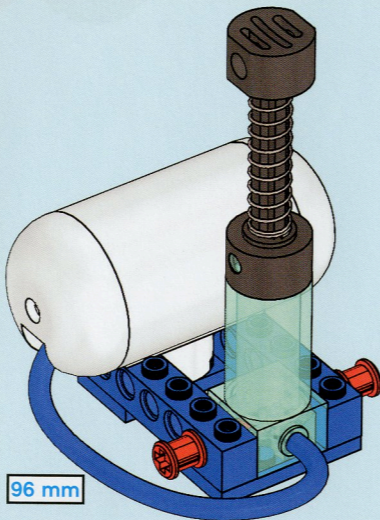

27

